



Sleeping

2024

Molteni & C

CONTENT



Beds

pp 10-95

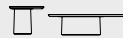

Coffee tables

pp 96-131



Drawer units

pp 132-179



Home office

pp 180-189



Mirrors and accessories

pp 190-193



**Bed sets
bed accessories**

pp 194-217

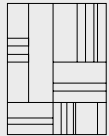

Carpet collection

pp 218-247



OVERVIEW

BEDS



Aldgate *Rodolfo Dordani* - p. 24



Anton *Vincent Van Duysen* - p. 56



Azul *Nicola Gallizia* - p. 32



Fulham *Rodolfo Dordani* - p. 64



High-Wave *Hannes Wettstein* - p. 82



Honey *Arik Levy* - p. 72



Ovidio *Vincent Van Duysen* - p. 12



Ribbon *Vincent Van Duysen* - p. 46



Wish *Rodolfo Dordani* - p. 90

SMALL TABLES



45°/Tavolino *Ron Gilad* - p. 118



Aster *Vincent Van Duysen* - p. 108



Attico *Nicola Gallizia* - p. 130



D.552.2 *Gio Ponti* - p. 98



D.555.1 *Gio Ponti* - p. 102



Domino Next *Nicola Gallizia* - p. 122



Fonte *Vincent Van Duysen* - p. 104



Louisa *Vincent Van Duysen* - p. 116



Panna Cotta *Ron Gilad* - p. 126



Regent *Vincent Van Duysen* - p. 112



Vicino Table *Foster + Partners* - p. 124



When *Rodolfo Dordani* - p. 128



OVERVIEW

DRAWER UNITS



4040 *Dante Bonuccelli* - p. 154



5050 *Rodolfo Dordoni* - p. 148



606 *Rodolfo Dordoni* - p. 156



7070 *Rodolfo Dordoni* - p. 136



909 *Luca Meda* - p. 160



Baltimora *Matteo Nunziati* - p. 164



Casper *Vincent Van Duysen* - p. 140



D.655.1 D.655.2 *Gio Ponti* - p. 132



MHC.1 *Werner Blaser* - p. 134



D.950.1 *Gio Ponti* - p. 190



Hector Mirror *Vincent Van Duysen* - p. 192



Teorema *Ron Gilad* - p. 144



505 UP Sideboard *Nicola Gallizia* - p. 168



Pass-Word Evolution *Dante Bonuccelli* - p. 176

WRITING DESKS - MIRRORS



D.847.1 *Gio Ponti* - p. 180



Note *Matteo Nunziati* - p. 184



Scriba *Patricia Urquiola* - p. 186



OVERVIEW

CARPET COLLECTION



D.754.1
Gio Ponti - Heritage Collection - p. 220



Atalante
by Ruckstuhl - Nicola Gallizia - p. 222



Aura
Nicola Gallizia - p. 224



Random
by Altai- Patricia Urquiola - p. 238



Sonoro
Nicola Gallizia - p. 240



Stripe
Vincent Van Duysen - p. 242



Dedalo
by Pierre Frey - Marta Ferri - p. 226



Duna
Nicola Gallizia - p. 228



Edge
Nicola Gallizia - p. 230



Telaro
by Amini - Marta Ferri - p. 244



Vibrazioni
Marta Ferri - p. 246



Eone
Nicola Gallizia - p. 232



Hem
by G.T.Design - Patricia Urquiola - p. 234



Palette
Nicola Gallizia - p. 236



WE SPEND NEARLY A THIRD OF OUR LIVES IN BED, NOT ONLY SLEEPING. WE DREAM AND WE DAYDREAM IN BED; WE MULL OVER OUR DAY AND PLAN THE NEXT ONE. WE READ IN BED. WE TALK IN BED. WE MAKE LOVE IN BED. A BED MUST BE WELCOMING AND SUPPORTING; IT MUST BE PRACTICAL AND FUNCTIONAL. IT MUST ALSO LOOK GOOD WHEN WE ARE AWAKE, WHEN WE LAY OUR HOLIDAY CLOTHES OUT ON IT, WHEN WE COME HOME IN THE EVENING ... AND WHEN WE JUST WANT TO DREAM A LITTLE LONGER.

A LETTO TRASCORRIAMO QUASI UN TERZO DELLA NOSTRA VITA. NON SEMPRE DORMENDO. A LETTO SI SOGNA, A OCCHI CHIUSI E A OCCHI APERTI, SI RIPENSA LA GIORNATA TRASCORSA E SI ANTICIPA QUELLA CHE VERRÀ. A LETTO SI LEGGE. A LETTO SI FA L'AMORE. A LETTO SI PARLA. UN LETTO DEVE SAPERCI ACCOGLIERE E SOSTENERE, DEVE ESSERE PRATICO E FUNZIONALE. MA DEVE ANCHE ESSERE BELLO DA VEDERE QUANDO. SIAMO SVEGLI, QUANDO CI BUTTIAMO SOPRA I VESTITI DELLE VACANZE, QUANDO TORNIAMO A CASA LA SERA. QUANDO, PER UN MOMENTO, ABBIAMO ANCORA VOGLIA DI SOGNARE.

beds



OVIDIO

VINCENT VAN DUYSSEN

The Ovidio bed by Vincent Van Duysen is designed to be the centrepiece of the bedroom: an extraordinary combination of sober elegance and utmost comfort, where no detail is left to chance and the leading role is played by the headboard. "This new bed is characterized by a blend of many details, a very elegant object that converses with a modern style," states Vincent Van Duysen. The headboard, a synthesis of research and refinement, is available both in leather and fabric. A discreet smoked metal frame with rounded corners carefully defines the structure. The front part, where the profile is straight, is covered in leather, available in the same colour as the upholstery (tone-on-tone) or in contrasting shades, allowing for the choice of a bolder or more subdued aesthetic. The facade is further enriched by "diamond" stitching that runs vertically throughout the element. The bed is available in three dimensions, 160, 180 cm, and a King size, for maximum flexibility within the space. Ovidio is a contemporary classic that combines modern design with unparalleled comfort. The bed's attention to detail, including the hand-stitched vertical seams in contrasting thread and flat aluminium frame, make it a truly exceptional piece of furniture and a standout addition to the bedroom.

Il letto Ovidio di Vincent Van Duysen è stato pensato per impreziosire la zona notte: una straordinaria combinazione di sobria eleganza e massimo comfort, dove nessun particolare viene lasciato al caso e dove il ruolo di protagonista è interpretato dalla testata. La testata, sintesi di valore e ricercatezza, è disponibile sia in pelle che in tessuto. Un profilo in metallo brunito con angoli arrotondati definisce discretamente la struttura. Nella parte anteriore, dove il profilo è rettilineo, è rivestito in pelle, disponibile nello stesso colore del rivestimento (tono su tono) o in tonalità contrastanti, consentendo la scelta di un'estetica più audace o più sussurrata. La facciata è ulteriormente arricchita da cuciture a "losanga" che corrono verticalmente per tutto l'elemento. È disponibile in tre dimensioni 160, 180 cm, King Size, per una flessibilità massima all'interno dello spazio. Il letto Ovidio è un classico contemporaneo che unisce un design moderno ad un comfort senza pari. La cura dei dettagli del letto, comprese le cuciture verticali realizzate a mano in filo a contrasto e la struttura in alluminio complanare, lo rendono un punto di ancoraggio visivo di tutto l'ambiente.



OVIDIO —

BED—
KOLO K1113 FABRIC,
UE122 LEATHER INSERT
REGENT COFFEE TABLES—
PORTA VOLTA LOW CHAIRS—
ATALANTE CARPET—

LETTO—
TESSUTO KOLO K1113,
INSERTO PELLE UE122
TAVOLINI REGENT—
SEDIE LOW PORTA VOLTA—
TAPPETO ATALANTE—



OVIDIO —

BED—
SIRIA S1221 LEATHER,
SIRIA S1221 LEATHER INSERT
ASTER AND REGENT
COFFEE TABLES—
GLISS MASTER WARDROBE—
TUSCANY CHAISE LONGUE—
PALETTE CARPET—

LETTO—
PELLE SIRIA S1221,
INSERTO PELLE SIRIA S1221
TAVOLINI
ASTER E REGENT—
ARMADIO GLISS MASTER—
CHAISE LONGUE TUSCANY—
TAPPETO PALETTE—





OVIDIO —

BED—
KOLIBRI KH934 FABRIC.
UE160 LEATHER INSERT
ASTER COFFEE TABLES—
GLISS MASTER WARDROBE—
PAULA ARMCHAIR AND POUF—
PALETTE CARPET—

LETTO—
TESSUTO KOLIBRI KH934.
INSERTO PELLE UE160
TAVOLINI ASTER—
ARMADIO GLISS MASTER—
POLTRONA E POUF PAULA—
TAPPETO PALETTE—





ALDGATE

RODOLFO DORDONI

Molteni&C broadens its range of beds with a sophisticated and elegant proposal by Rodolfo Dordoni. The cooperation with the Milanese designer has led to Aldgate, a bed conceived as an island devoted to rest and relaxation. Designed as an isolated element, totally autonomous and self-sufficient, able to fit in with all kinds of bedroom furniture, Aldgate presents carefully designed details and soft, delicate and snug lines. Its heart is a container with rounded edges, upholstered in textiles or in leather and with sartorial finishes, embellished by a surrounding pewter frame that incorporates the bed, which can be positioned at different heights, and the rectangular backrest that recalls a monumental access road to the city. That too is rounded and it features two comfy cushions to lean back on. A bench to be placed at the foot of the bed completes the project.

Molteni&C, amplia la sua gamma di proposte letto, con una sofisticata ed elegante proposta di Rodolfo Dordoni. Dalla collaborazione con il designer milanese nasce così Aldgate, un letto concepito come un'isola dedicata al riposo e al relax. Pensato come un elemento isolato, totalmente autonomo e autosufficiente, capace di integrarsi con ogni tipologia di arredo della camera da letto, Aldgate presenta particolari studiati con cura e linee morbide, delicate, avvolgenti. Il cuore è un contenitore dai bordi arrotondati, rivestito in tessuto o in pelle e dalle finiture sartoriali, impreziosito da una cornice perimetrale verniciata in peltro che incorpora il piano letto, posizionabile a diverse altezze, e lo schienale a forma rettangolare che ricorda una via di accesso monumentale alla città. Anch'esso a forma arrotondata si caratterizza nella parte anteriore dalla presenza di due comodi cuscini d'appoggio. Una panca da posizionare ai piedi del letto completa il progetto.

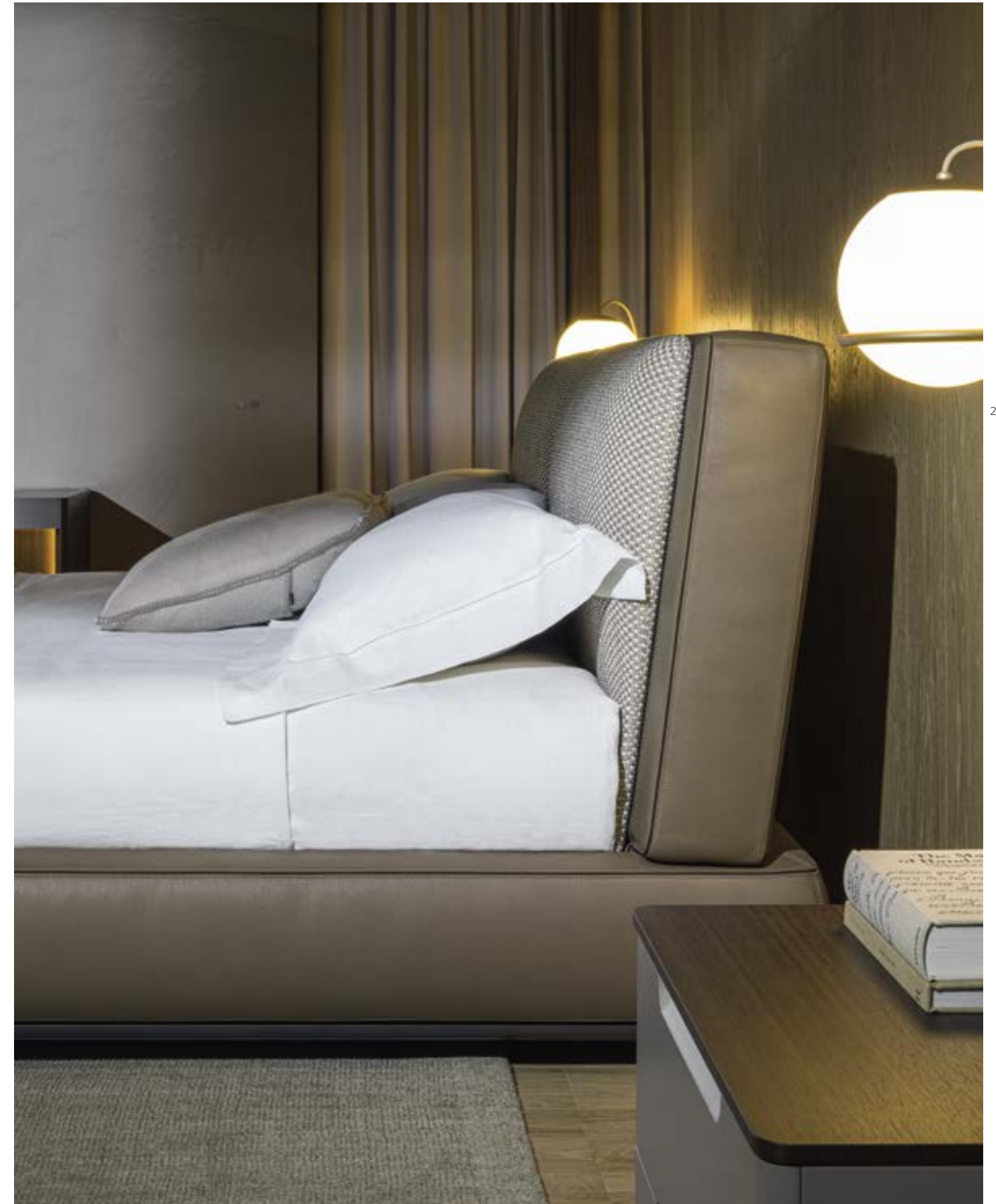

ALDGATE —

BED—
UNIQUE UE130 STRUCTURE,
KUBO KH623
HEADBOARD CUSHIONS
7070 NIGHT TABLES—
AURA CARPET—

LETTO—
STRUTTURA UNIQUE UE130,
CUSCINI TESTATA
KUBO KH623
COMODINI 7070—
TAPPETO AURA—



ALDGATE—

BED—
KIWI KH520 STRUCTURE,
SIRIA S1220
HEADBOARD CUSHIONS
BENCH—
SIRIA S1220,
GLOSSY PEWTER COLOUR PROFILE,
BLACK NICKEL COLOUR FEET
LOUISA COFFEE TABLE—
BRICK RED COLOUR STRUCTURE
AND BRICK RED COLOUR CEMENT TOP
505 UP SIDEBOARD—
EDGE CARPET—

LETTO—
STRUTTURA KIWI KH520,
CUSCINI TESTATA
SIRIA S1220
PANCA—
SIRIA S1220,
PROFILO PELTRO LUCIDO,
PIEDI NICKEL NERO
TAVOLINO LOUISA—
STRUTTURA COLOR MATTONE
E TOP IN CEMENTO COLOR MATTONE
505 UP SIDEBOARD—
TAPPETO EDGE—



ALDGATE —

BENCH—
SCIROCCO SD930,
GLOSSY PEWTER COLOUR PROFILE,
BLACK NICKEL COLOUR FEET
BOUCLÉ PLAID—

PANCA—
SCIROCCO SD930,
PROFILO PELTRO LUCIDO,
PIEDI NICKEL NERO
PLAID BOUCLÉ—



AZUL

NICOLA GALLIZIA

Exquisite details and delicate but clear lines contribute to the fascination and emotions aroused by this decidedly contemporary design. The surprising aesthetic balance is achieved by reducing the superfluous and by the well-proportioned construction of the individual component parts. Two sheets of bonded hide leather sewn together or with fabric or leather upholstery, the result of refined workmanship, elegantly enrich the lines. The surface of the bed comes in two heights plus the option of an extra storage compartment underneath, Azul reinvents the image of the bedroom, proposing a new way of sleeping, a synthesis of Nicola Gallizia's styling skills and Molteni&C's flair for innovation.

Particolari studiati con cura, linee delicate ma nette, trasmettono un coinvolgente fascino e suscitano forti suggestioni per un progetto dalla decisa vocazione alla contemporaneità. Il sorprendente equilibrio estetico nasce dalla riduzione di qualsiasi elemento superfluo e dalla costruzione proporzionata delle singole componenti. Due fogli in cuoio rigenerato cuciti o in rivestimento tessile, o pelle, frutto di lavorazioni raffinate, ne disegnano e arricchiscono elegantemente le linee. Il piano del letto è disponibile in due altezze più la possibilità di un contenitore supplementare nella parte sottostante, Azul reinventa l'immagine della zona notte proponendo un nuovo modo di dormire, sintesi della capacità stilistica di Nicola Gallizia e dell'attitudine a sperimentare di Molteni&C.



AZUL. —

BED AND BENCH—
BLACK BONDED HIDE LEATHER,
BLACK FINISH BED FEET
PLUSH PLAID—
DOMINO NEXT COFFEE TABLE—
PEWTER COLOUR STRUCTURE,
SILVER WAVE MARBLE TOP
DEDALO CARPET—

LETTO E PANCA—
CUOIO RIGENERATO NERO,
PIEDI LETTO FINITURA NERO OPACO
PLAID PLUSH—
TAVOLINO DOMINO NEXT—
STRUTTURA PELTRO,
PIANO MARMO SILVER WAVE
TAPPETO DEDALO—





AZUL —

BENCH—
BLACK BONDED HIDE LEATHER

PANCA—
CUOIO RIGENERATO NERO



AZUL—

BED—
KYLE KG611 FABRIC,
BLACK FINISH BED FEET
BENCH—
IVORY BONDED HIDE LEATHER
BOUCLE PLAID—
CASPER NIGHT TABLE—
HECTOR NIGHT—
AURA CARPET—

LETTO—
TESSUTO KYLE KG611,
PIEDI FINITURA NERO OPACO
PANCA—
CUOIO RIGENERATO AVORIO
PLAID BOUCLE—
COMODINO CASPER—
HECTOR NIGHT—
TAPPETO AURA—



AZUL. —

BED—
DOVE GREY BONDED HIDE LEATHER,
MATT BLACK FINISH FEET
ATTICO COFFEE TABLE—
PEWTER AND
SATIN BRASS BASE,
EMPERADOR DARK MARBLE TOP
WALTER ARMCHAIR—
EDGE CARPET—

LETTO—
CUOIO RIGENERATO TORTORA,
PIEDI FINITURA NERO OPACO
TAVOLINO ATTICO—
BASAMENTO PELTRO E
OTTONE SATINATO,
PIANO MARMO EMPERADOR DARK
POLTRONA WALTER—
TAPPETO EDGE—



AZUL. —

BED—
DOVE GREY BONDED HIDE LEATHER,
MATT BLACK FINISH FEET
ATTICO COFFEE TABLES—
PEWTER AND
SATIN BRASS BASE,
EMPERADOR DARK MARBLE TOP
EDGE CARPET—

LETTO—
CUIO RIGENERATO TORTORA,
PIEDI FINITURA NERO OPACO
TAVOLINI ATTICO—
BASAMENTO PELTRO E
OTTONE SATINATO,
PIANO MARMO EMPERADOR DARK
TAPPETO EDGE—





AZUL. —

BED—
DOVE GREY BONDED HIDE LEATHER,
MATT BLACK FINISH FEET

LETTO—
CUOIO RIGENERATO TORTORA,
PIEDI FINITURA NERO OPACO



RIBBON

VINCENT VAN DUYSSEN

Ribbon is a fabulously soft textile bed with a young, modern design, using natural materials. The textile or leather upholstery hooks up to a ribbon, with leather details, that runs all the way round the headboard and bed and serves both a structural and an aesthetic purpose. The tall and softly padded headboard makes it a highly contemporary product.

Ribbon è un letto tessile con caratteristiche di assoluta morbidezza unita ad un design giovane e moderno, utilizzando materiali naturali. Il rivestimento, tessile o di pelle, si aggancia a un nastro, con dettagli in pelle, che corre lungo tutto il perimetro della testata e del giroletto, con funzioni sia strutturali che estetiche. La testata alta, e la morbida imbottitura ne fanno un prodotto di grande contemporaneità.



RIBBON —

BED—
KYLE KG612 FABRIC,
EDGING IN L209 LEATHER
ANTON BENCH—
L209 LEATHER,
PEWTER COLOUR FEET
BOUCLE PLAID—
ATTICO COFFEE TABLES—
ROUND D.154.5 ARMCHAIR—
AURA CARPET—

LETTO—
TESSUTO KYLE KG612,
BORDO PELLE L209
PANCA ANTON—
PELLE L209,
PIEDI FINITURA PELTRO
PLAID BOUCLE—
TAVOLINI ATTICO—
POLTRONA ROUND D.154.5—
TAPPETO AURA—

RIBBON —

BED—
WILUNA WF543 FABRIC,
EDGING IN EXTRA LEATHER L147
5050 NIGHT TABLE—
EUCALYPTUS,
ANTHRACITE GLOSSY LACQUERED

LETTO—
TESSUTO WILUNA WF543,
BORDO PELLE EXTRA L147
COMODINO 5050—
EUCALIPTO,
LACCATO LUCIDO ANTRACITE





RIBBON —

BED—
WILUNA WF543 FABRIC,
EDGING IN EXTRA LEATHER L147
5050 NIGHT TABLE—
EUCALYPTUS,
ANTHRACITE GLOSSY LACQUERED

LETTO—
TESSUTO WILUNA WF543,
BORDO PELLE EXTRA L147
COMODINO 5050—
EUCALIPTO,
LACCATO LUCIDO ANTRACITE



RIBBON —

BEDS—
WEB W6213 FABRIC,
EXTRA LEATHER L198 EDGING
FONTE LOUNGE TABLE—
BLACK OAK STRUCTURE,
GLOSSY CALACATTA
MARBLE TOP
FONTE COFFEE TABLE—
STRUCTURE AND TOP
COFFEE OAK

LETTI—
TESSUTO WEB W6213,
BORDO PELLE EXTRA L198
TAVOLO LOUNGE FONTE—
STRUTTURA ROVERE NERO,
TOP MARMO
CALACATTA LUCIDO
TAVOLINO FONTE—
STRUTTURA E TOP
ROVERE CAFFÈ



ANTON

VINCENT VAN DUYSSEN

A bed that perfectly expresses Vincent Van Duysen's design philosophy, where essentiality and carefully chosen materials achieve a perfect synthesis. Delicate but clean lines for a harmonious aesthetic balance, the result of reducing anything superfluous. Carefully studied details with delicate but clear lines transmit an impact of fascinating charm and evoke strong suggestions of a decisive, contemporary furnishing scheme; the seams delicately outline the proportions. Volumes which are emphasized thanks to a particular type of stitching used for the head board, the capitonné, revised in a contemporary way. Feet finished in pewter colour. Upholstery that can be completely detachable in the Molteni&C range of leather and textiles. Anton can be combined with a bench with identical frame finishings and matching upholstery.

Un letto che s'inserisce a pieno nella filosofia progettuale di Vincent Van Duysen, dove essenzialità e studio dei materiali impiegati raggiungono una sintesi perfetta. Linee delicate ma nette per un equilibrio estetico armonioso, frutto della riduzione di qualsiasi elemento superfluo, trasmettono d'impatto un coinvolgente fascino e suscitano forti suggestioni per un progetto dalla decisa vocazione alla contemporaneità, dove le cuciture ne ridisegnano elegantemente le proporzioni. Volumi che grazie al particolare tipo di cucitura impiegata per la testata, il capitonné, rivisitato in una chiave contemporanea, vengono messi in rilievo. Piedi in finitura peltro. Rivestimenti completamente sfoderabili nella gamma tessuti e pelli Molteni&C. Ad Anton può essere abbinata una panca con finiture della struttura e tipologia di rivestimento identici.

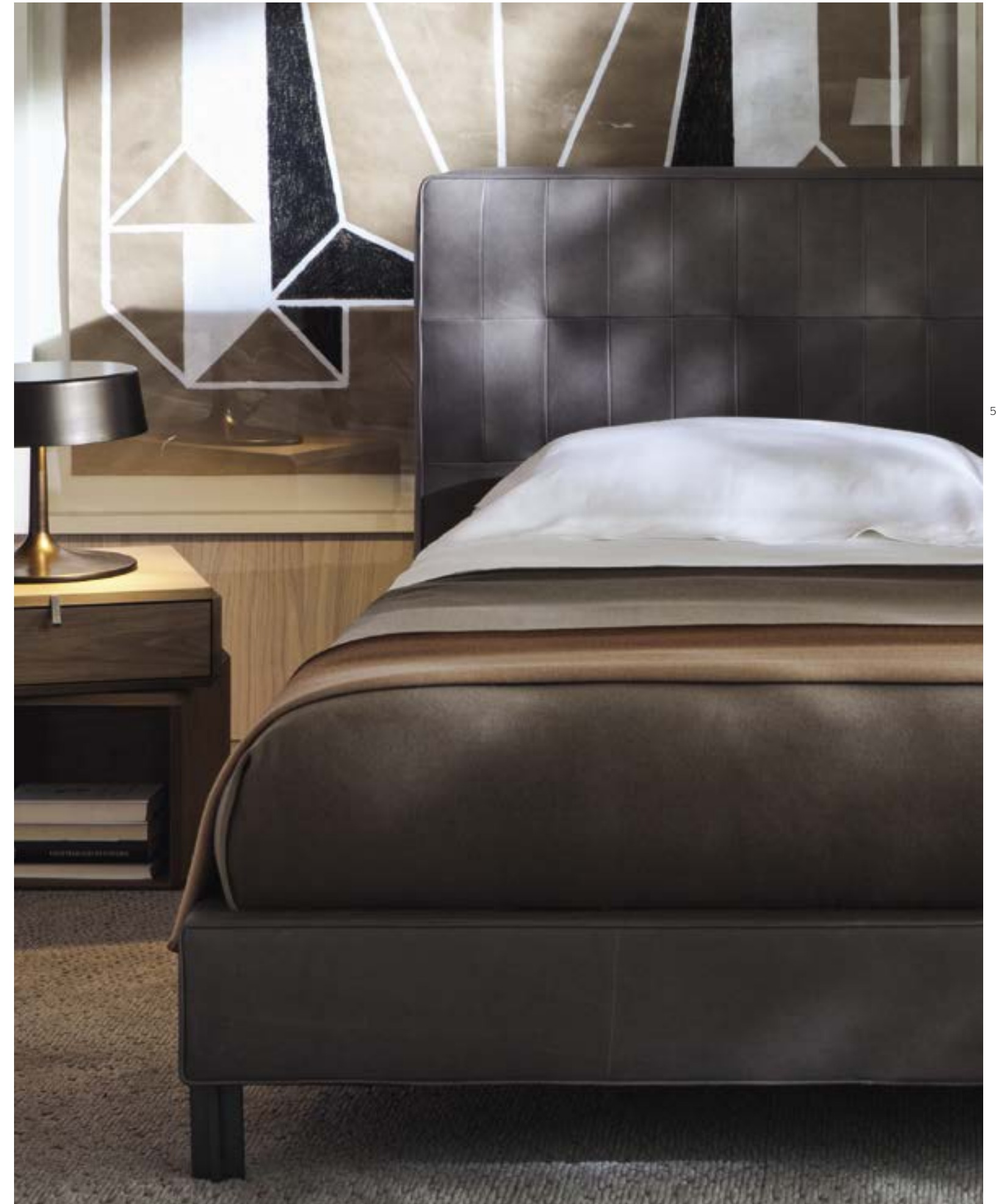

ANTON —

BED AND BENCH—
PANDORA PD522 LEATHER,
PEWTER COLOUR FEET
SOFT PLAID—
DOLOMITE AND RUST COLOURS
TEOREMA DRAWER UNIT—
AMERICAN WALNUT
RANDOM CARPET—

LETTO E PANCA—
PELLE PANDORA PD522,
PIEDI FINITURA PELTRO
PLAID SOFT—
COLORI DOLOMITE E RUST
CONTENITORE TEOREMA—
NOCE CANALETTO
TAPPETO RANDOM—





ANTON —

BED AND BENCH—
PANDORA PD522 LEATHER,
FEET PEWTER COLOUR
SABLE PLAID—
OLIVE COLOUR

LETTO E PANCA—
PELLE PANDORA PD522,
PIEDI FINITURA PELTRO
PLAID SABLE—
COLORE OLIVE

ANTON —

BED—
PANDORA PD522 LEATHER,
FEET PEWTER COLOUR
SOFT PLAID—
DOLOMITE AND RUST COLOURS
TEOREMA DRAWER UNIT—
AMERICAN WALNUT
D.555.1 SMALL TABLE—
METAL LEGS AND
TRANSPARENT GLASS TOP
RANDOM CARPET—

LETTO—
PELLE PANDORA PD522,
PIEDI FINITURA PELTRO
PLAID SOFT—
COLORI DOLOMITE E RUST
CONTENITORE TEOREMA—
NOCE CANALETTO
TAVOLINO D.555.1—
GAMBE METALLICHE,
PIANO CRISTALLO TRASPARENTE
TAPPETO RANDOM—



FULHAM

RODOLFO DORDONI

Fulham road gives its name to the bed that the designer has created for a comfortable and regenerating night's sleep. The wrap-around textile or leather headboard provides a cosy and relaxing niche in which to rest, read or watch television. A bench to be placed at the foot of the bed completes the project. Fabric and leather covers are completely removable. Woods: eucalyptus, black oak, graphite oak and coffee oak. Two different bedframes: lower bedframe H.4 3/8" (bed base height 12 5/8"), higher bedframe H.8 1/2" (bed base height 16 3/4").

Fulham, un letto nato per un riposo confortevole e rigenerante. La testata avvolgente, in tessuto o pelle, permette di creare intorno a sé un confortevole ambiente dove riposarsi, leggere o guardare la televisione in tutto relax. Una panca da posizionare ai piedi del letto completa il progetto. I rivestimenti in tessuto e pelle sono completamente sfoderabili. Essenze: eucalipto, rovere nero, rovere grafite e rovere caffè. Due differenti versioni di fascia: fascia bassa H.11 (altezza piano letto 32), fascia alta H.21,5 (altezza piano letto 42,5).



FULHAM—

BED—
EUCALYPTUS STRUCTURE,
WILUNA WF580 FABRIC
ATTICO COFFEE TABLE—
PEWTER AND
SATIN BRASS BASE,
EMPERADOR DARK MARBLE TOP
4040 NIGHT TABLE—
EUCALYPTUS
KENSINGTON ARMCHAIR—
EDGE CARPET—

LETTO—
STRUTTURA EUCALIPTO,
TESSUTO WILUNA WF580
TAVOLINO ATTICO—
BASAMENTO PELTRO E
OTTONE SATINATO,
PIANO MARMO EMPERADOR DARK
COMODINO 4040—
EUCALIPTO
POLTRONA KENSINGTON—
TAPPETO EDGE—





FULHAM —

BED—
EUCALYPTUS STRUCTURE,
WILUNA WF580 FABRIC

LETTO—
STRUTTURA EUCALIPTO,
TESSUTO WILUNA WF580

FULHAM —

BED AND BENCH—
GRAPHITE OAK STRUCTURE,
KASSANDRA K3790 FABRIC
D.552.2 SMALL TABLE—
5050 DRAWER UNIT—
GRAPHITE OAK AND
MOKA GLOSSY LACQUERED,
DARK BROWN ECO SKIN
LOWER SHELF
HEM CARPET—

LETTO E PANCA—
STRUTTURA ROVERE GRAFITE,
TESSUTO KASSANDRA K3790
TAVOLINO D.552.2—
CONTENITORE 5050—
ROVERE GRAFITE E
LACCATO LUCIDO MOKA,
PIANO INFERIORE
ECO SKIN TESTA DI MORO
TAPPETO HEM—



HONEY

ARIK LEVY

Sobri fabric bed with soft, comfortable headboard and tailored upholstery. The bed Honey's slatted bases are fixed and moving manual and/or electric bases cannot be used. The feet are in black lacquered metal (fixed version) or chromed steel (container version). Fabric or leather covering, are completely removable. Two slatted bases positions are possible in the version with container: front opening for moving stored objects, and horizontal raising to ease making bed.

Letto tessile dalla linea sobria, caratterizzato dalla comoda e morbida testata e dalla lavorazione sartoriale del rivestimento. Nel letto Honey il posizionamento delle reti è fisso e non possono essere inserite reti con movimento manuale e/o elettrico. I piedini sono in metallo verniciato nero (versione fissa) o acciaio cromato (versione con contenitore). I rivestimenti in tessuto e pelle sono completamente sfoderabili. Nella versione con contenitore la rete ha due posizionamenti: apertura frontale per movimentare i materiali contenuti e sollevamento orizzontale per un comodo rifacimento del letto.



HONEY —

BED—
UNIQUE UE122 LEATHER
LOUISA COFFEE TABLES—
EUCALYPTUS
D.555.1 SMALL TABLE—
METAL LEGS AND
TRANSPARENT GLASS TOP
PICCADILLY ARMCHAIR—
STRIPE CARPET—

LETTO—
PELLE UNIQUE UE122
TAVOLINI LOUISA—
EUCALIPTO
TAVOLINO D.555.1—
GAMBE METALLICHE,
PIANO CRISTALLO TRASPARENTE
POLTRONA PICCADILLY—
TAPPETO STRIPE—



HONEY —

BED—
UNIQUE UE122 LEATHER

LETTO—
PELLE UNIQUE UE122



HONEY —

BED—
WING WG222 FABRIC.
TURN-UP EDGING
ANDROMEDA A3530 FARIC
45°/TAVOLINO SMALL TABLE—
AMERICAN WALNUT
909 DRAWER UNITS—
CLAY MATT/GLOSSY LACQUERED
D.3571 BOOKCASE—

LETTO—
TESSUTO WING WG222.
RISVOLTO/PROFILATURA
TESSUTO ANDROMEDA A3530
45°/TAVOLINO—
NOCE CANALETTO
CONTENITORI 909—
LACCATO OPACO/LUCIDO ARGILLA
LIBRERIA D.3571—





HONEY —

BED—
SIRIA S1230 LEATHER

LETTO—
PELLE SIRIA S1230



HIGH-WAVE

HANNES WETTSTEIN

Classic upholstered bed with contained proportions, embellished with vertical cord piping on the padded headboard. For the version with the mechanism, the internal part of the headboard can be tilted to provide an adjustable tabletop area. The crosspieces connecting the guides of the bed can support single or divided slatted bases, and the height of the base can be adjusted. This model is also available with a bed-base storage container. The feet are always in shiny chrome finish. Fabric and leather covers are completely removable.

Letto imbottito dalla forma classica e dalle misurate proporzioni, arricchito dalla cordonatura verticale del rivestimento della testata. Nella versione con meccanismo la parte interna della testata può inclinarsi per fornire un appoggio modulabile. Il letto, grazie ai traversi che collegano le guide, può ricevere reti intere o divise e l'altezza delle stesse può essere regolata; inoltre è disponibile anche nella versione con contenitore sottorete. I piedini sono sempre in finitura cromo lucido. I rivestimenti in tessuto o pelle sono completamente sfoderabili.



HIGH-WAVE —

BED—
ARIS A4096 FABRIC
45"/TAVOLINO SMALL TABLE—
BLACK OAK
PANNA COTTA SMALL TABLE—
BLACK MATT LACQUERED
WITH BLACK MARQUINA MARBLE
606 DRAWER UNIT—
SILICA MATT LACQUERED,
FEET BLACK NICKEL FINISH

LETTO—
TESSUTO ARIS A4096
45"/TAVOLINO—
ROVERE NERO
TAVOLINO PANNA COTTA—
LACCATO OPACO NERO
CON MARMO NERO MARQUINA
CONTENITORE 606—
LACCATO OPACO SILICE,
PIEDI FINITURA NICKEL NERO





HIGH-WAVE —

BED—
EXTRA L212 LEATHER
BED—
WITCH W3622 FABRIC

LETTO—
PELLE EXTRA L212
LETTO—
TESSUTO WITCH W3622





HIGH-WAVE —

BED—
EXTRA L212 LEATHER
D.555.1 SMALL TABLE—
METAL LEGS AND
TRANSPARENT GLASS TOP

LETTO—
PELLE EXTRA L212
TAVOLINO D.555.1—
GAMBE METALLICHE,
PIANO CRISTALLO TRASPARENTE

WISH

RODOLFO DORDONI

Minimal and refined solid wood double bed in perfect harmony. Soft cushions for the fabric or leather headboard are matched with the following types of wood: black oak, graphite oak and coffee oak. Fabric and leather cushions covers are completely removable. The bed can take all types of slatted bases in a variable thickness 5,5 - 9,5 cm (2 1/8" - 3 3/4") thanks to an adjustable support system.

Letto matrimoniale in legno massello dalle linee essenziali e raffinate. Morbidi cuscini per la testata in tessuto o pelle si combinano con i legni: rovere nero, rovere grafite e rovere caffè. I rivestimenti dei cuscini in tessuto e pelle sono completamente sfoderabili. Il letto può accogliere ogni tipo di rete di spessore variabile da 5,5 a 9,5 cm grazie al sistema d'appoggio regolabile.

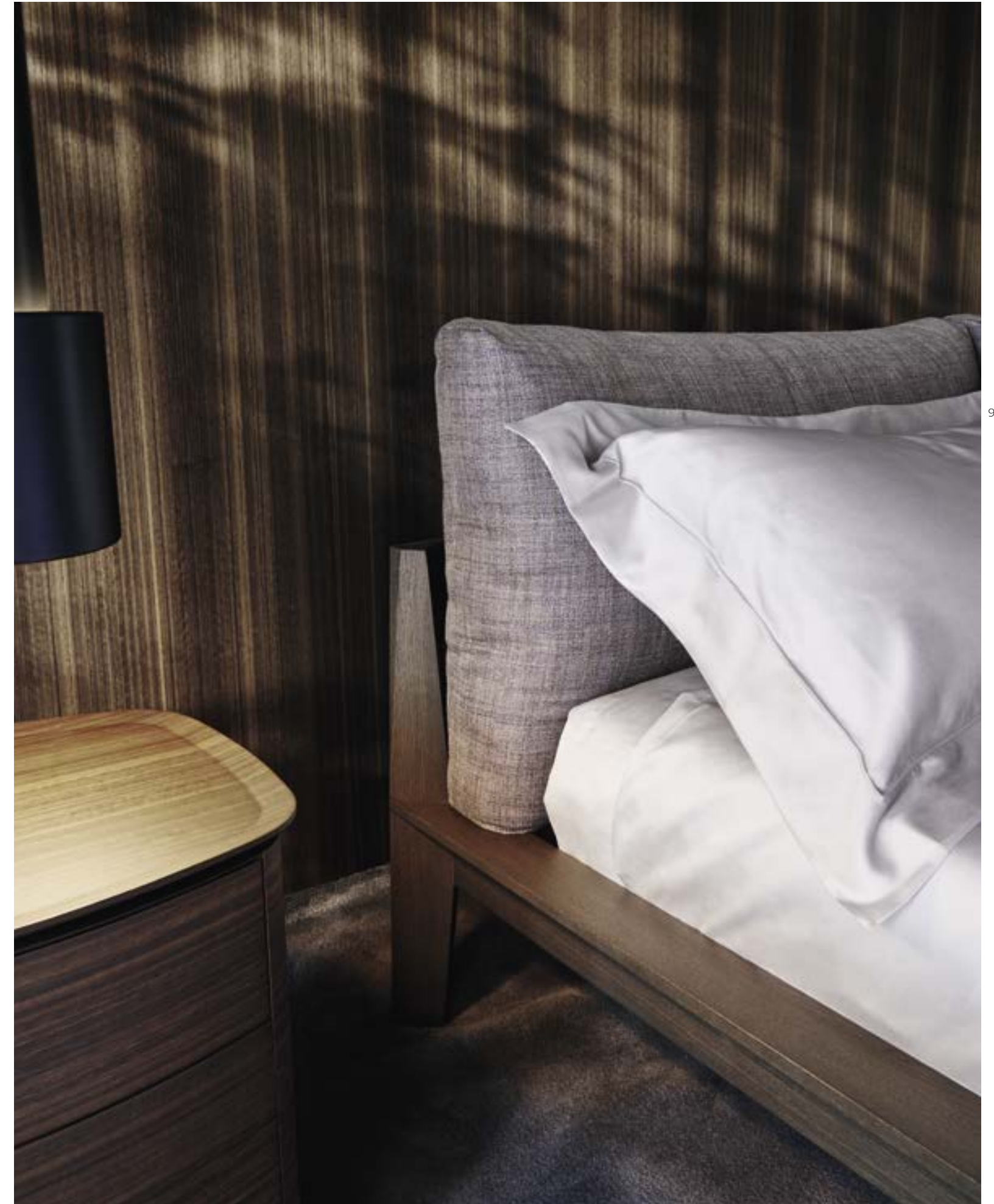

WISH —

BED—
WAIT WE735 FABRIC,
BLACK OAK STRUCTURE
4040 NIGHT TABLE—
EUCALYPTUS
D.552.2 SMALL TABLE—
SOLID ROSEWOOD
STRUCTURE,
SATIN BRASS FEET,
EXTRALIGHT GLASS TOP
D.151.4 ARMCHAIR—
EDGE CARPET—

LETTO—
TESSUTO WAIT WE735,
STRUTTURA ROVERE NERO
COMODINO 4040—
EUCALIPTO
TAVOLINO D.552.2 —
STRUTTURA MASSELLO
DI PALISSANDRO,
PIEDI OTTONE SATINATO,
PIANO VETRO EXTRACHIARO
POLTRONA D.151.4—
TAPPETO EDGE—





WISH —

BED—
SIRIA S1221 LEATHER,
GRAPHITE OAK STRUCTURE
WHEN SMALL TABLE—
GRAPHITE OAK STRUCTURE
AND SHELVES

LETTO—
PELLE SIRIA S1221,
STRUTTURA ROVERE GRAFITE
TAVOLINO WHEN—
STRUTTURA E PIANI
ROVERE GRAFITE



FURNITURE IS ROOTED IN THE GREAT, POSITIVE, ARTISAN TRADITION AND YET, CONTINUITY, HISTORICAL REFERENCES AND MEMORY SIT UNEASILY WITH AN OPEN, INCLUSIVE, EXPERIMENTAL APPROACH THAT TRIES TO INCORPORATE NEW TECHNOLOGIES AND NEW SOLUTIONS. PROFILES BEVELS, JOINS, DIFFERENT MATERIALS ALL MAKE UP THE INHERENT POETRY OF PERFECTION AND DETAIL. MUCH OF THE BEAUTY OF FURNITURE LIE PRECISELY IN THIS PERFECTION.

I MOBILI HANNO RADICI IN UNA GRANDE E POSITIVA TRADIZIONE ARTIGIANALE: E TUTTAVIA, CONTINUITÀ, RIFERIMENTO E MEMORIA CONVIVONO IN DIFFICILE EQUILIBRIO CON UN ATTEGGIAMENTO SPERIMENTALE E APERTO, INCLUSIVO, CHE PROVA AD INCORPORARE NUOVE TECNOLOGIE E NUOVE SOLUZIONI. SAGOME, SMUSSI, ATTACCHI, PASSAGGI DI MATERIE, COSTITUISCONO DALL'INTERNO UNA POETICA DELLA PERFEZIONE E DEL DETTAGLIO. IN QUESTA PERFEZIONE STA MOLTA DELLA BELLEZZA DEI MOBILI.

small tables and complements

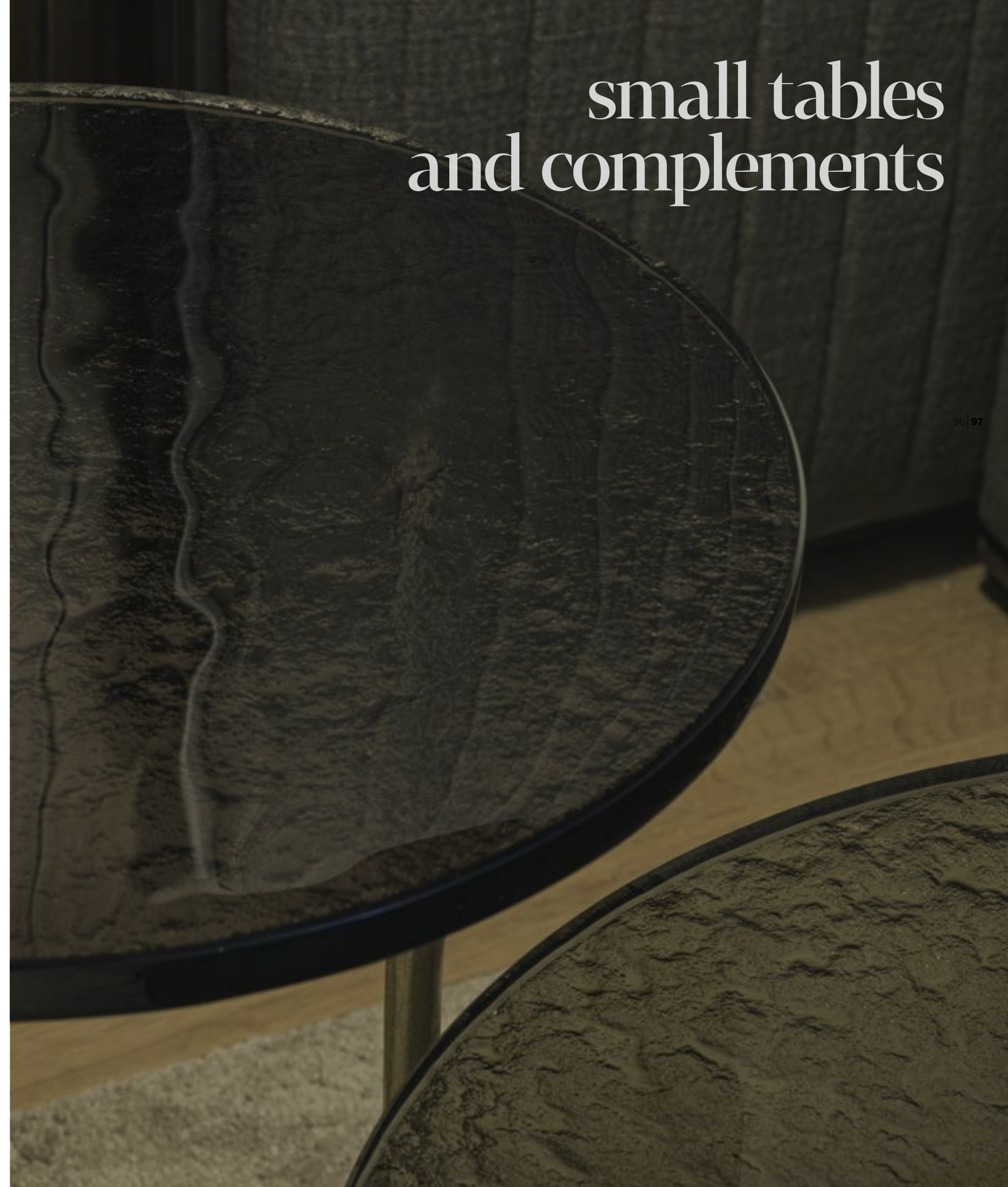

D.552.2

GIO PONTI

Small table with a rounded triangular shape, designed in the mid-1950s and originally destined to the american market. Solid rosewood structure and transparent extra-light glass top. Feet: satin brass.

Tavolino dalla forma triangolare arrotondata progettato a metà degli anni '50 e originariamente destinato al mercato americano. Struttura in massello di palissandro e piano in vetro trasparente extrachiaro. Piedi: ottone satinato.

**HERITA-
GE COL-
LECTION**



D.552.2 —

SMALL TABLE—
SOLID ROSEWOOD
STRUCTURE,
SATIN BRASS FEET,
EXTRALIGHT GLASS TOP

TAVOLINO—
STRUTTURA MASSELLO
DI PALISSANDRO,
PIEDI OTTONE SATINATO,
PIANO VETRO EXTRACHIARO



D.555.1

GIO PONTI

From Gio Ponti's house, located in via Dezza in Milan, the small table D.555.1, designed in 1954-1955, is produced by Molteni&C based on the original drawings from the Gio Ponti Archives. Metal hand painted structure and glass top.

**HERITA-
GE COL-
LECTION**

Dalla casa di Gio Ponti in via Dezza a Milano, il tavolino D.555.1, disegnato nel 1954-1955, è prodotto da Molteni&C sulla base dei disegni originali custoditi nei Gio Ponti Archives. Struttura e gambe in metallo, con griglia colorata verniciata a mano, il piano è in cristallo trasparente.



FONTE

VINCENT VAN DUYSSEN

Within the Fonte series, circular volumes meet refined craftsmanship, creating sophisticated lounge complements suitable for any setting. Resting on three vertical oak stained solid wood uprights, the circular base of the Fonte coffee tables showcases any one of a rich array of tabletop materials such as marble, essence, or black back-painted glass, offering versatility in design. The subdued hues of the tabletops harmonize with the coffee and black oak finishes, creating a delicate interplay of solidity and fluidity that exudes timeless charm. Completing the collection are a bedside table and a refined lounge table, each meticulously crafted to enhance functionality and style. The bedside table features a practical drawer and a sophisticated upper ring with an elegant burnished painted finish, while the lounge table offers a generous surface area.

La serie di tavolini Fonte, contraddistinta dal suo volume circolare, è concepita come sofisticati complementi lounge adatti a una varietà di ambienti. Partendo da una base circolare, la struttura si regge su tre montanti verticali in legno massello tinto rovere, mentre il piano sfoggia un materiale dotato di profonda espressività come il marmo. In alternativa, è possibile optare per un top in essenza o vetro retroverniciato nero che conferisce un tocco più leggero. Le tonalità del top si riflettono nelle finiture rovere caffè e rovere nero per le parti in essenza, sono tonalità posate e solide che giocano in contrasto con la sensazione di leggerezza e fluidità, creando nell'oggetto un flusso equilibrato e bilanciato di pieno-vuoto. La gamma si completa con l'aggiunta di un tavolino-comodino e un raffinato tavolo lounge. La versione comodino mantiene le forme e dimensioni dei tavolini, arricchendosi di un pratico cassetto posizionato sotto il piano e un sofisticato anello superiore dall'elegante verniciatura effetto brunito.





FONTE —

< p.105
 LOUNGE TABLE—
 BLACK OAK STRUCTURE,
 GLOSSY CALACATTA
 MARBLE TOP
 COFFEE TABLE—
 STRUCTURE AND TOP
 COFFEE OAK
 RIBBON BEDS—

COFFEE TABLE—
 COFFEE OAK STRUCTURE,
 BLACK TEMPERED
 BACK-PAINTED GLASS

p.105
 TAVOLO LOUNGE—
 STRUTTURA ROVERE NERO,
 TOP MARMO
 CALACATTA LUCIDO
 TAVOLINO—
 STRUTTURA E TOP
 ROVERE CAFFÈ
 LETTI RIBBON—

TAVOLINO—
 STRUTTURA ROVERE CAFFÈ,
 TOP VETRO TEMPERATO
 RETROVERNICIATO NERO



ASTER

VINCENT VAN DUYSEN

The Aster coffee table, designed by Vincent Van Duysen, is the ultimate expression of compositional rationality and craftsmanship. A unique object made entirely by hand, a contemporary work of art that combines aesthetics and functionality. Each table has a slightly different connotation, testifying to its handcrafted nature. Its base features a brass casting made with an earth mould that gives it the sophisticated hammered effect. The ring is mounted to the legs by welding. A vibratory finishing technique completes the aesthetics. With the help of stones, the structure is gently smoothed, giving it a wavy effect. The top is made of annealed glass with a thickness of 1.9 cm and features a slight ripple in the lower area that adds personality. Again, the manufacturing technique is extremely meticulous: the sheet is placed in a mould with a textured bottom and fused at 180° C, giving the glass its distinct finish. Aster is available in two sizes: 50 cm in height with a 40 cm top in diameter, or 40 cm by 50 cm. Finishes are available in polished brass or black patinated brass, while the top can be customised in smoked or green. The Aster coffee table is a piece with a sculptural value, which can be used transversally to collections and spaces.

Il tavolino Aster, design di Vincent Van Duysen, è l'espressione massima di razionalità compositiva e di capacità artigianale. Un oggetto unico realizzato totalmente a mano, un'opera d'arte contemporanea che unisce estetica e funzionalità. Ogni tavolo ha una connotazione leggermente diversa, a testimoniare la sua natura artigianale. La base di Aster è caratterizzata da una fusione d'ottone realizzata con uno stampo in terra che le conferisce il sofisticato effetto martellato. L'anello è assemblato alle gambe tramite saldatura. La tecnica della vibrofinitura ne completa l'estetica. Mediante l'ausilio di sassi, la struttura viene gentilmente levigata, restituendo un effetto mosso. Il top è costituito da un vetro ricotto dallo spessore di 1,9 cm e contraddistinto, nella parte inferiore, da una leggera increspatura che dona personalità. Anche in questo caso la tecnica di realizzazione è meticolosa: la lastra viene collocata in uno stampo con un fondo bugnato e fusa ad una temperatura di 180 gradi, conferendo al vetro la sua tipica finitura. Aster è disponibile in due misure: in altezza 50 cm con top di diametro 40 cm e in altezza 40 cm e diametro 50 cm. Le finiture della struttura sono disponibili in ottone lucido o in ottone patinato nero mentre il top è personalizzabile in due colori - smoked o verde. Il tavolino Aster è un elemento forgiato dal valore scultoreo, che può essere utilizzato trasversalmente alle collezioni e agli ambienti.





ASTER —

COFFEE TABLES—
 POLISHED BRASS
 WITH SMOKED
 TEXTURED GLASS TOP,
 PATINATED BLACK BRASS
 WITH GREEN
 TEXTURED GLASS TOP
 GLISS MASTER WARDROBE—
 PALETTE CARPET—

TAVOLINI—
 OTTONE LUCIDO
 CON PIANO VETRO
 RICOTTO SMOKED,
 OTTONE NERO PATINATO
 CON PIANO VETRO
 RICOTTO VERDE
 ARMADIO GLISS MASTER—
 TAPPETO PALETTE—



REGENT

VINCENT VAN DUYSSEN

The Regent coffee tables signed by Vincent Van Duysen are the indoor interpretation of the version launched in the Molteni&C Outdoor Collection. In conceiving the new Regent coffee tables, Van Duysen makes a statement on the essential fluidity of his designs, demonstrating that, aesthetically, these forms can live comfortably in any context and can create a natural continuity between indoor and outdoor. The base of the Regent table is composed of a burnished metal ring with slender legs. A mirror-image structure supports the table top, which is available in several different finishes: lava stone in anthracite, olive green, desert yellow colours and lava stone with matt finish. To enrich the indoor version, lava stone with a glossy polyester finish, black marquina and calacatta marble with a matt or glossy polyester finish. The Regent tables come in several different proportions and shapes. From low, oval-shaped versions, ideal for use as a coffee table, to taller, round editions that sit easily as a side table next to a sofa. The Regent's versatility, paired with its sophisticated, minimal shape, marks a step forward in the longstanding collaboration between Molteni&C and Van Duysen, opening the door to interpreting the historic brand's extensive catalogue in entirely new contexts and environments.

I tavolini Regent firmati Vincent Van Duysen sono la riproposizione indoor della versione lanciata per la Collezione Outdoor Molteni&C. Nel concepire i nuovi tavolini, Van Duysen dimostra la fluidità e l'essenzialità dei suoi progetti, comprovando che esteticamente queste forme possono vivere comodamente in qualsiasi contesto e possono creare una naturale continuità tra l'interno e l'esterno. La base dei tavolini Regent è composta da un anello in metallo brunito arricchito da gambe sottili che ne creano la struttura. Una struttura speculare sostiene il piano del tavolino realizzato in differenti finiture: pietra lavica smaltata in color antracite, verde oliva, giallo deserto e pietra lavica finitura opaca. Ad arricchire la versione indoor, pietra lavica finitura poliester lucido, in marmo nero marquina e calacatta in finitura opaca o poliester lucido. Il tavolo Regent è disponibile in diverse proporzioni e forme. Dalle versioni basse di forma ovale, ideali per l'uso come tavolino da caffè, alle varietà rotonde, che si adattano facilmente come struttura d'appoggio accanto ad un divano. La versatilità di Regent, unita alla sua forma sofisticata e minimale, segna un passo avanti nella lunga collaborazione tra Molteni&C e Vincent Van Duysen, aprendo le porte all'interpretazione dell'ampio catalogo dello storico marchio in contesti e ambienti completamente nuovi.

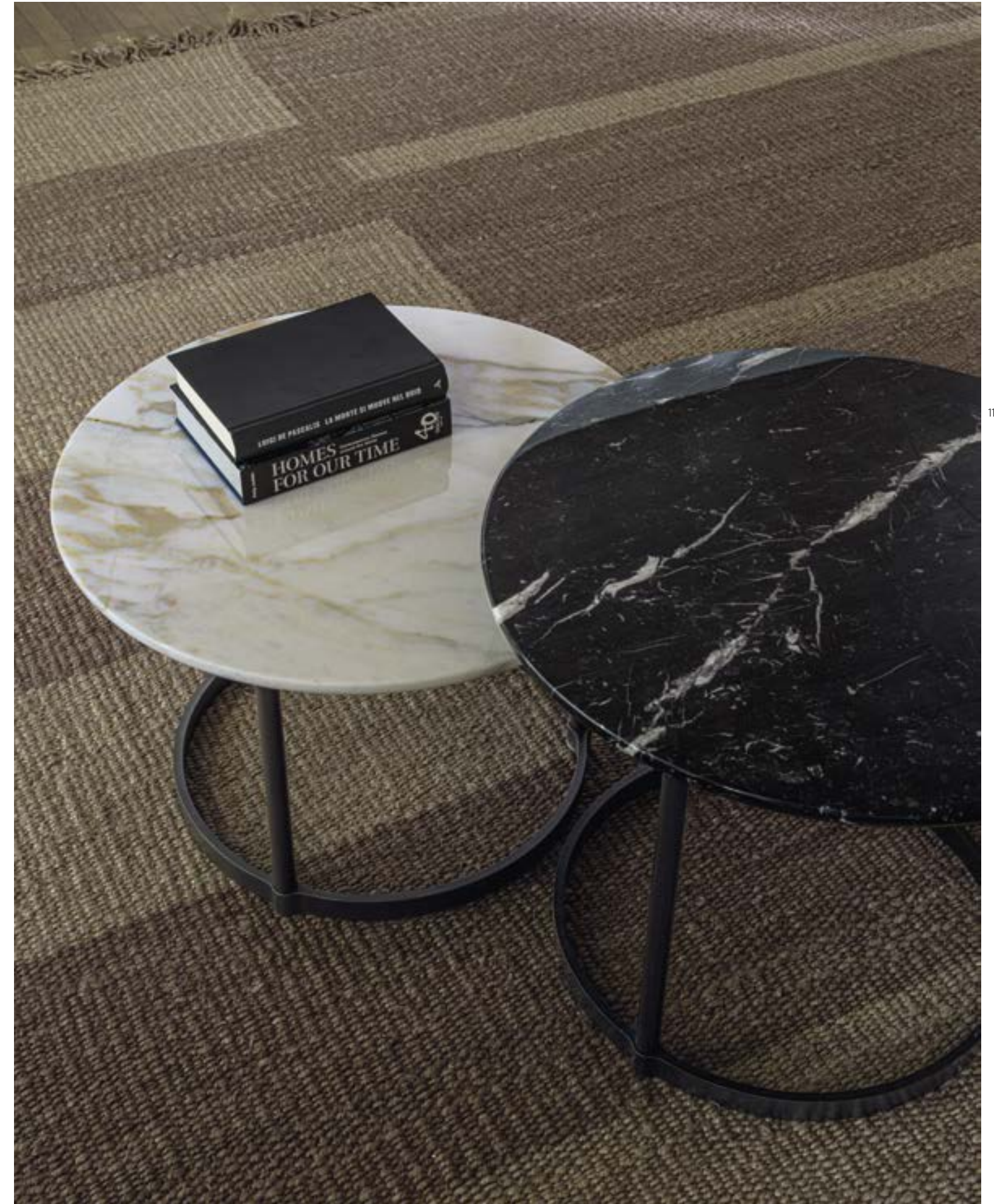

REGENT —

< p. 113
COFFEE TABLES—
BURNISHED
METAL STRUCTURE,
CALACATTA AND BLACK
MARQUINA MARBLE TOP
ATALANTE CARPET—

p. 113
TAVOLINI—
STRUTTURA
METALLO BRUNITO,
PIANI MARMO CALACATTA
E NERO MARQUINA
TAPPETO ATALANTE—

REGENT —

COFFEE TABLES—
BURNISHED
METAL STRUCTURE,
LAVA STONE TOP
GLOSSY POLYESTER FINISH
ATALANTE CARPET—

TAVOLINI—
STRUTTURA
METALLO BRUNITO,
PIANO PIETRA LAVICA
FINITURA POLIESTERE LUCIDO
TAPPETO ATALANTE—



LOUISA

VINCENT VAN DUYSSEN

Vincent Van Duysen has designed Louisa, a set of round and oval coffee tables in which the presence of both wood and cement conveys an innovative tactile and aesthetic effect. The load-bearing structure, a conical central plinth, is raised from the floor and inserted into a space hollowed out within it. The table tops, a bit like suspended trays, come in ash, brick red or white cement or in wood and feature an original radial motif, achieved by means of a special procedure for joining up the slabs. The base is made of curved plywood covered with wood or of bent sheet metal painted. Transversal objects, combined at will, simply, lightly, elegantly: the quintessence of modern design.

Vincent Van Duysen progetta Louisa, una serie di tavolini tondi e ovali in cui la presenza del legno e del cemento è dichiarata con una percezione tattile ed estetica innovativa. La struttura portante, un plinto centrale conico, si solleva da terra e si innesta in un piano scavato al suo interno. I piani, quasi dei vassoi in sospensione, possono essere in cemento colore cenere, rosso mattone o bianco, o in essenza e si contraddistinguono per un originale motivo raggiato, ottenuto tramite un particolare procedimento di giunzione delle lastre. Il basamento è realizzato in curvato di multistrato rivestito di essenza o in lamiera piegata verniciata. Oggetti trasversali, combinabili tra loro a piacimento, con semplicità, leggerezza, eleganza: la quintessenza del design moderno.



45°/TAVOLINO

RON GILAD

45°/Tavolino by Ron Gilad, underlines the designer's interest in basic geometric shapes. A series of "open box" small tables, of which we can only see the contours, easy to integrate into all furnishing solutions with character.

45°/Tavolino di Ron Gilad, conferma l'interesse del designer per le forme geometriche essenziali. Qui una serie di tavolini a "scatola aperta" di cui vediamo solo i contorni, facilmente integrabili in tutte le soluzioni abitative.





45°/TAVOLINO —

SMALL TABLE—
AMERICAN WALNUT

SMALL TABLE—
BLACK OAK

TAVOLINO—
NOCE CANALETTO

TAVOLINO—
ROVERE NERO



DOMINO NEXT

NICOLA GALLIZIA

In his search for stylized forms and characterful materials, Nicola Gallizia develops a series of versatile and complementary units that can fit into each other or be set side by side, such as small oval tables and pouf. They are made using and alternating steel, wood, stone, textiles and leather. Color, matter and form are the inspiration and the synthesis of the collection.

Nicola Gallizia sviluppa un programma di elementi versatili per costruzione e utilizzo, basato sulla ricerca di forme stilizzate e materiali dalla spiccata personalità, in un continuo gioco a rincorrersi e sovrapporsi. Complementi, come tavolini ovali e pouf, utilizzabili per qualsiasi espressione progettuale, sono realizzati utilizzando e alternando acciaio, legno, pietra, tessuti e pelle. Colore, materia e forma sono l'ispirazione e la sintesi della collezione.



VICINO TABLE

FOSTER + PARTNERS

As in all Foster + Partners designs, the hi-tech component is essential for its development. The basic idea is that of a small table which, thanks to sideways movable tops, can act not only as a surface for objects, but also as a device for bringing whatever is required into the foreground. The steel frame conceals a sophisticated mechanism for the traverse movement of the slim but structurally effective marble or wood table tops. A perfectly designed structure for a highly contemporary project.

Come in ogni progetto di Foster + Partners, la componente tecnologica risulta fondamentale per il suo sviluppo. Alla base l'idea di un tavolino che, attraverso movimenti dei piani, fungesse non solo da appoggio di oggetti ma consentisse anche il loro spostamento per portare in primo piano ciò che serve. La struttura, realizzata in acciaio, nasconde un meccanismo sofisticato di traslazione dei piani in marmo o essenza, molto sottili ma strutturalmente molto efficaci. Una struttura dal disegno perfetto, simbolo della contemporaneità del progetto.



PANNA COTTA

RON GILAD

Panna Cotta low table oval or round. At once delicate and heavy, the paradox lies in the use of materials such as marble and iron to achieve a fragile stability. Base and top made of white, black or green lacquered metal, combined with tone-on-tone white Carrara, black marquina or green alpine marbles.

Panna Cotta, tavolino ovale o rotondo, delicato e pesante allo stesso tempo, paradosso nell'uso di materiali come marmo e ferro per ottenere una fragile stabilità. Struttura e piano in metallo laccato bianco, nero o verde, abbinati a marmi tono su tono, in bianco Carrara, nero marquina, verde alpi.



WHEN

RODOLFO DORDONI

Occasional furnishings in solid wood which complete the living area and the bedroom thanks to the structure design which follows the lines of the bed Wish.

Complementi d'arredo in legno massello integrabili nella zona giorno o nella zona notte grazie al design della struttura che riprende le linee del letto Wish.



ATTICO

NICOLA GALLIZIA

Attico is a collection of coffee tables featuring a sophisticated simplicity of lines, available in a choice of top quality materials. Even when an object is defined, technology intervenes to guarantee its purpose as a useful instrument for building the shape of the environment and for suggesting a different way of approaching the home space. Attico's salient feature is the original central three legged base with rounded corners, typical of the Milanese designer, made of cast aluminium with a pewter colour painted finish, with shiny chrome or satin brass profile, which can be used in different ways. The tops can be round or triangular, with buffered forms in the thickness of the top. The finishes of the tops can be made of marble: emperador dark, orient grey, calacatta, Sahara noir, green alpine, silver wave, red lepanto.

Attico è una collezione di tavolini caratterizzati da una sofisticata semplicità delle linee, declinata in una scelta di materiali di grande pregio. Anche laddove l'oggetto è un elemento definito, la tecnica interviene garantendo la loro funzione di strumenti utili per costruire la forma dell'ambiente e per suggerire un modo diverso di pensare lo spazio abitato. Attico si caratterizza per l'originale base centrale a tre cuspidi dagli angoli arrotondati, tratto caratteristico del designer milanese, in fusione di alluminio e verniciata color peltro, con profilatura cromo lucido o ottone satinato, che può adeguarsi a diverse forme di utilizzo. I piani possono essere rotondi o triangolari, dalle forme smussate nello spessore del piano. Le finiture dei piani possono essere in marmo: emperador dark, grigio oriente, calacatta, Sahara noir, verde alpi, silver wave, rosso lepanto.

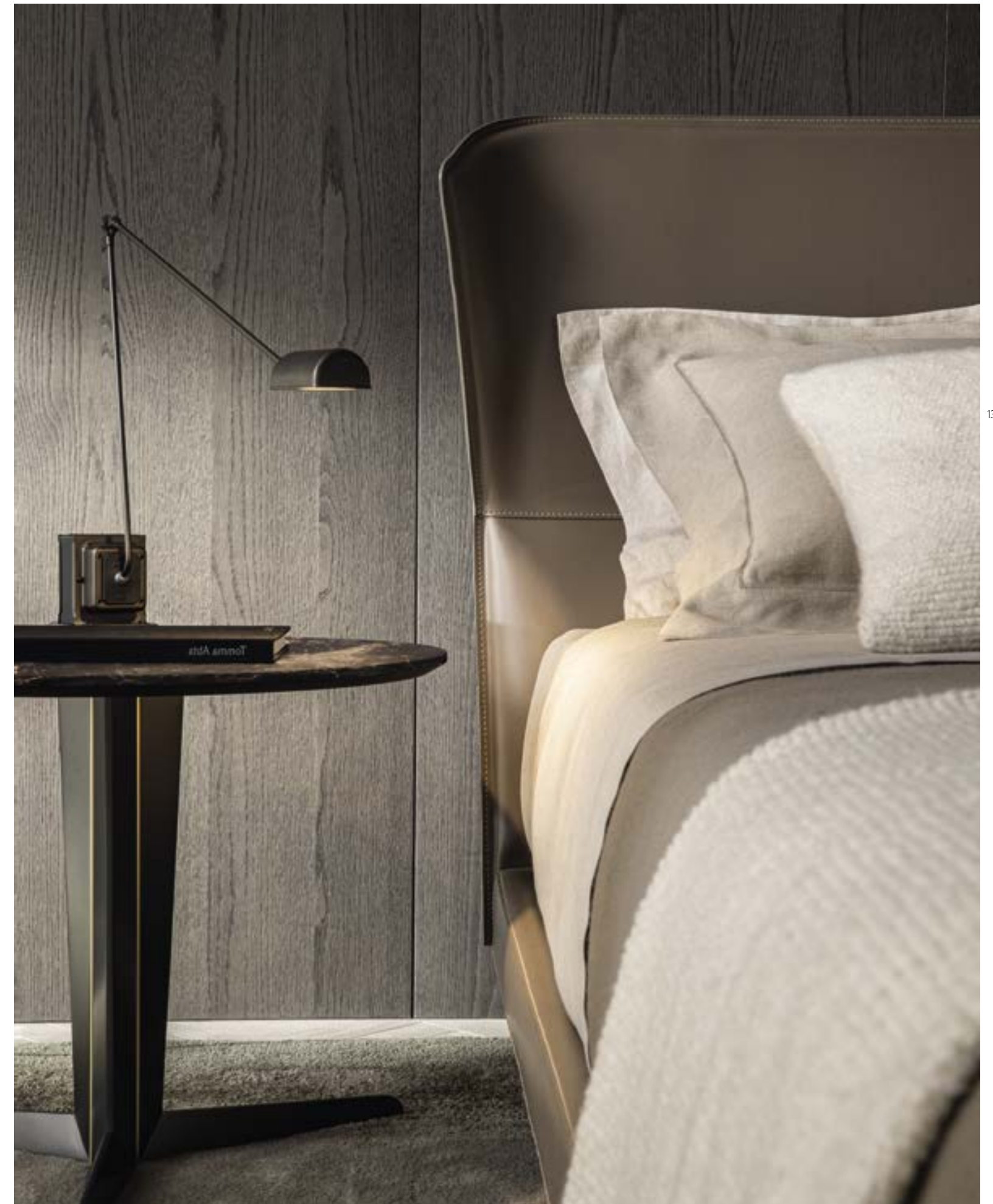

D.655.1 D.655.2

GIO PONTI

Chest of drawers designed in several versions in the period from 1952 to 1955. This re edition is produced based on the original drawings from the Gio Ponti Archives. Marked by handpainted white drawer fronts with applied handles in various wood kinds (elm, Italian walnut, mahogany and rosewood). The elmwood frame rests on satin brass feet.

Comò disegnato in diverse varianti tra il 1952 e il 1955. La riedizione è prodotta sulla base dei disegni originali custoditi nei Gio Ponti Archives. È caratterizzato dai frontali dei cassetti verniciati a mano in colore bianco con maniglie applicate di varie essenze (olmo, noce nazionale, mogano e palissandro). La struttura in essenza di olmo è sostenuta da piedini in ottone satinato.

HERITAGE COLLECTION

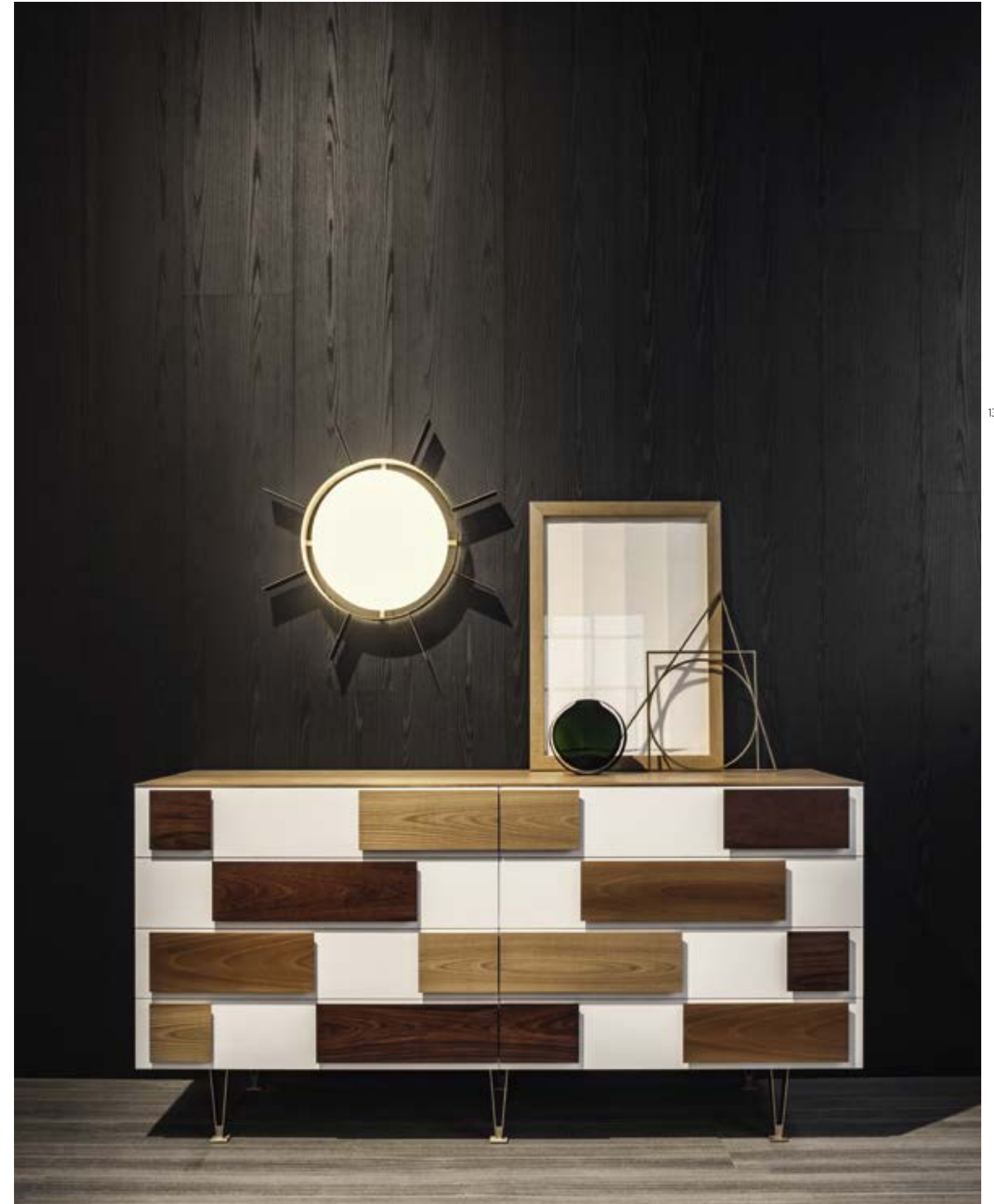

MHC.1

WERNER BLASER

MHC.1 is a new edition of the prototype of the first modern piece of furniture made by Molteni&C, the chest of drawers designed by Werner Blaser. Thought it was never produced industrially, in 1955 it won first prize at the Cantù "Prima Mostra Selettiva - Concorso internazionale del mobile", a competition designed to re-qualify the image of Italian furniture making. The jury was made up of Gio Ponti, Alvar Alto, Romano Barocchi, Carlo de Carli and Finn Juhl. The unusual joinery features a simple three-fork joint. After issuing a limited edition run of 100 numbered pieces, two new non-numbered versions are available in the new black stained and honey stained ash finishes.

MHC.1 è una riedizione del prototipo del primo mobile moderno realizzato da Molteni&C, il cassettone disegnato da Werner Blaser. Mai entrato in produzione, vince il primo premio al concorso internazionale di Cantù del 1955, Prima Mostra Selettiva, indetto per riqualificare l'immagine produttiva italiana. La giuria è composta da Gio Ponti, Alvar Alto, Romano Barocchi, Carlo de Carli e Finn Juhl. Particolare il sistema costruttivo basato sulla giunzione semplice a triplice forcella. Dopo una prima riedizione limitata di 100 pezzi numerati, è ora disponibile in due nuove versioni non numerate nelle inedite finiture frassino tinto nero e tinto miele.

HERITAGE COLLECTION



7070

RODOLFO DORDONI

Since as far back as the 1950s, Molteni&C has been a leader in innovative solutions for the nighttime area, which include a wide choice of beds as well as complete and functional suggestions for storage. Hence 7070, a fascinating nighttime system to provide the area traditionally devoted to rest and relaxation with a new series of nighttime complements, modernly designed to meet the needs of contemporary living. Rodolfo Dordoni has designed a complete set, where fine materials and finishes combine with a sober and elegant design for new functional aesthetic solutions. Both units, bedside table and drawers feature a front with rounded corners, which lightens the structure. The drawers in the drawer units and in the night tables are lacquered in the colours of the Molteni&C range and are fitted with fine, recessed and easy-to-grip pewter handles. One novel feature is the superimposed tray-cum-drawer, again made of eucalyptus wood, complete with a transparent ribbed glass top. As an alternative, the bedside table and the chest of drawers can be enriched with a slim eucalyptus top, matt lacquers colours or marble top.

Fin dagli anni '50, Molteni&C è leader nelle soluzioni innovative per la zona notte, che comprendono un'ampia offerta di letti e proposte per il contenimento, complete e funzionali. Così 7070, un sistema notte di grande fascino per declinare la zona tradizionalmente dedicata al riposo e al relax attraverso una nuova serie di complementi notte, modernamente progettati per rispondere alle esigenze del vivere contemporaneo. Rodolfo Dordoni disegna un sistema completo, dove pregiati materiali e finiture si coniugano con un design sobrio ed elegante per nuove soluzioni estetico-funzionali. Entrambi gli elementi, comodino e cassettoni presentano un frontale con angoli arrotondati, che dona leggerezza alla struttura. I cassetti nelle cassettiere e nei comodini sono laccati nei colori della gamma cromatica di Molteni&C e sono dotati di preziose maniglie in peltro, incassate e di facile presa. Un elemento di novità è il cassetto-vassoio sovrapposto, sempre in essenza eucalipto, dotato di un top in vetro millerighe trasparente. In alternativa, comodino e cassettiere possono essere arricchiti da un sottile top in eucalipto, laccato opaco colori oppure in marmo.

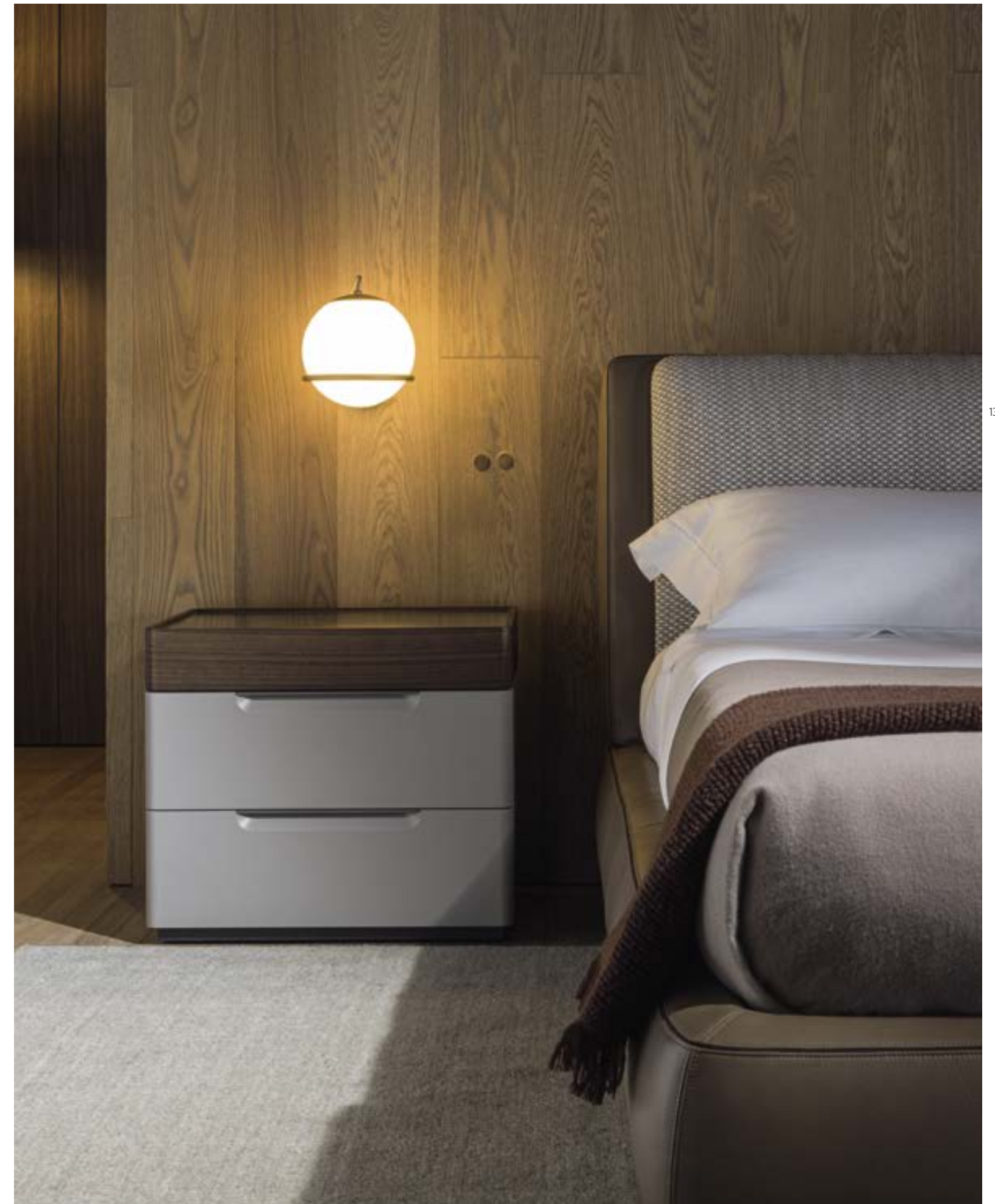



7070 —

NIGHT TABLE—
EUCALYPTUS OR
FUTES GLASS TOP,
LONDON SKY MATT LACQUER
STRUCTURE

COMODINO—
TOP EUCALIPTO O
VETRO FLUTES,
STRUTTURA LACCATO OPACO
LONDON SKY



CASPER

VINCENT VAN DUYSSEN

Bedside table with one or two drawers and four-drawer chest of drawers. A rigorous and minimalist design, by the Belgian architect, destined for the bedroom. Surfaces in glossy or matt lacquer, pewter or copper colour painted alternate with eucalyptus, graphite oak or coffee oak woods. The tops are lined in matching shades of Eco Skin. The Casper design is distinguished by practicality and simplicity, making it perfect for all the bedrooms proposed by Molteni&C.

Comodino con uno o due cassetti e cassetiera a quattro cassetti. Progetto rigoroso e minimalista, del designer belga, destinato alla camera da letto. Superfici in lacca lucida od opaca, verniciate color peltro o rame si alternano a piani in essenza eucalipto, rovere grafite o rovere caffè. I top sono rivestiti in Eco Skin in tonalità di colore omogenee. La funzionalità abbinata alla semplicità sono le cifre progettuali che contraddistinguono Casper, rendendolo così perfetto per tutti gli ambienti notte proposti da Molteni&C.





CASPER —

DRAWER UNIT—
MOKA GLOSSY LACQUERED
DRAWERS FRONT AND BACK,
COPPER MATT LACQUERED
SIDES AND HANDLES,
DARK BROWN ECO SKIN TOP

CONTENITORE—
FRONTALE CASSETTI E SCHIENALE
LACCATO MOKA LUCIDO,
SPALLE LATERALI E MANIGLIE
LACCATO OPACO RAME,
TOP ECO SKIN TESTA DI MORO



TEOREMA

RON GILAD

A unit with open compartments or drawers used as a single unit or stacked in a linear or offset mode, to create night tables, chests of drawers or modular systems for the living area. Structure completely faceted like a diamond and made of a single piece veneered in American walnut, eucalyptus or coffee oak. The construction is a perfect fusion of precision mechanical working and artisanal skills in the folding and gluing of the piece.

Elemento singolo o composto sovrapponendo vari elementi per dare vita a comodini, cassettiere, composizioni per la zona living lineari o disassate. Struttura completamente sfaccettata a diamante ricavata da un unico pezzo rivestito in noce canaletto, eucalipto o rovere caffè. La realizzazione è il perfetto connubio tra la precisione centesimale della lavorazione meccanica e la sapienza artigianale nella piegatura e nell'incollaggio della struttura.





TEOREMA —

DRAWER UNIT—
AMERICAN WALNUT,
SHINY CHROME HANDLE

CONTENITORE—
NOCE CANALETTO,
MANIGLIA CROMO LUCIDO



5050

RODOLFO DORDONI

The wealth of materials used and a rigorous design are the elements that characterize 5050, a collection of bedroom furniture designed by Rodolfo Dordoni. Gloss or matt lacquered surfaces alternate with wooden tops and Eco Skin trays, creating alternating color effects that please the eye and underscore the play of solids and voids of a geometric design that is never banal. An interesting feature is the rounded contour of the structural elements that make up bedside tables and chests of drawers.

Ricchezza dei materiali impiegati e un disegno rigoroso sono gli elementi che caratterizzano 5050, una collezione di complementi notte progettata da Rodolfo Dordoni. Superfici in lacca lucida od opaca si alternano a piani in essenza e vassoi in Eco Skin, creando così una piacevole alternanza cromatica che sottolinea il gioco tra pieni ed i vuoti di un progetto geometrico mai banale. Interessante il profilo arrotondato degli elementi strutturali che vanno a comporre comodini e cassettoni.







5050 —

NIGHT TABLE—
GRAPHITE OAK,
MOKA GLOSSY LACQUERED

DRAWER UNIT—
GRAPHITE OAK AND
MOKA GLOSSY LACQUERED,
DARK BROWN ECO SKIN
LOWER SHELF

COMODINO—
ROVERE GRAFITE,
LACCATO LUCIDO MOKA

CONTENITORE—
ROVERE GRAFITE E
LACCATO LUCIDO MOKA,
PIANO INFERIORE
ECO SKIN TESTA DI MORO



4040

DANTE BONUCCELLI

4040 is a generously proportioned bedside unit and an ideal companion for the wide range of beds offered by Molteni&C. Framework and drawers are made of wood and rest on a pewter-coloured metal base. The top can be in wood or marble. Woods: eucalyptus, sunrise oak, graphite oak, coffee oak; marble top: white Carrara, emperador dark, black marquina, orient grey, silver wave, green alpine, red lepanto.

4040 è un comodino da notte dalle forme generose, ideale compagno dell'ampia offerta di letti proposti da Molteni&C. Struttura e cassetti, in essenza, poggiano su un basamento metallico di colore peltro. Il top è sempre in essenza o marmo. Essenze: eucalipto, rovere sunrise, rovere grafite, rovere caffè; piano marmo: bianco Carrara, emperador dark, nero marquina, grigio oriente, silver wave, verde alpi, rosso lepanto.



606

RODOLFO DORDONI

A range of drawer units distinguished by a clean and elegant design, characterized by the handle-free front and etched coloured glass top. 606 is available either with a floor standing base (always in anthracite finish) or supported by a shiny chrome or black nickel metal frame. Thanks to its wide range of finishes, 606 is a versatile product easily fitting to any furnishing ambience. Drawer unit: eucalyptus or graphite oak; matt lacquered in the Molteni "colours range".

Serie di cassettiere dal design sobrio ed elegante caratterizzate dal frontale senza maniglia e dal top in vetro acidato colorato. 606 è disponibile con zoccolo a terra (sempre finitura antracite) oppure appoggiato su un cavalletto in finitura cromo lucido o nickel nero. La notevole ampiezza di finiture rende 606 un prodotto versatile per l'utilizzo in qualsiasi soluzione d'arredo. Cassettiere: eucalipto o rovere grafite; laccato opaco nella "gamma colori" Molteni.





606 —

DRAWER UNITS—
BURGUNDY MATT LACQUERED,
ETCHED GLASS TOP
D.950.1 FRAMED MIRRORS—

CONTENITORI—
LACCATO OPACO BORGOGNA,
TOP VETRO ACIDATO
CORNICI CON SPECCHIO D.950.1—



158 | 159

909
LUCA MEDA

Flexible system of drawer units with pressure-opening or opening with handle enriched by an elegant open compartment in shiny aluminium or pewter colour and etched glass. 909 is available in the finishes matt lacquered (with the option of glossy lacquered drawer fronts to match the matt lacquered structure), or glossy lacquered. Finishes: eucalyptus or graphite oak; matt, or glossy lacquered in the Molteni "colours range"; glossy or etched lacquered glass in the Molteni "colours range".

Sistema flessibile di mobili a cassetti con apertura a pressione o con maniglia che si completa con un elegante vano a giorno in alluminio lucido o peltro con vetro acidato. 909 è disponibile nelle finiture laccato opaco (con la possibilità dei frontali cassetti laccato lucido in abbinamento con la struttura laccato opaco), oppure laccato lucido. Finiture: eucalipto o rovere grafite; laccato opaco o laccato lucido nella "gamma colori" Molteni; vetro lucido o acidato nella "gamma colori" Molteni.





909 —

DRAWER UNITS—
CLAY GLOSSY LACQUERED,
SHINY CHROME FEET FINISH,
PRESSURE-OPENING

CONTENITORI—
LACCATO LUCIDO ARGILLA,
PIEDI CROMO LUCIDO,
APERTURA A PRESSIONE



BALTIMORA

MATTEO NUNZIATI

Baltimore is a double-sided storage-display island, perfect for use in the centre of the room. Versatile and eclectic, it can adapt to any proposal in the bedroom area, creating a unicum with existing wardrobes or walk-in closets. Available in 148,2 and 181 cm, it is designed to elegantly contain, display, and accommodate any item intended for the dressing room area. The Baltimore is extremely functional with a dual purpose: storing objects related to the bedroom area and, thanks to the bench with soft cushions available in all the fabrics and leathers of the Molteni&C collection, creating a welcoming seating area. In addition, the two drawers located at the bottom of the bench become another storage element. The island, with soft and rounded lines, is composed of a transparent glass top with a frame in pewter, bronze, and iris. Or, alternatively, a top in ecoskin with a wood structure, onto which the cushions are placed, which are available in all the fabrics and leather in the Molteni&C collection.

Baltimore è un'isola contenitore-espositore bifacciale, perfetta per un utilizzo in centro stanza. Versatile ed eclettica, può adattarsi a qualsiasi proposta nella zona notte, creando un unicum con cabine o armadi esistenti. Disponibile nelle misure 148,2 e 181 cm, è pensata per contenere, esporre ed accogliere con eleganza ogni elemento destinato alla zona della dressing room. Un elemento estremamente funzionale dalla doppia utilità: contenere gli oggetti relativi alla zona notte e, grazie alla panca dalle soffici cuscinate disponibili in tutti i tessuti e le pelli della collezione Molteni&C, creare una postazione accogliente e inaspettata, che acquisisce ulteriore spazio. I due cassetti posizionati nella parte inferiore della panca, aggiungono un ulteriore elemento al prodotto. L'isola, dalle linee morbide e stondate, è composta da un top in vetro trasparente con un telaio in peltro, bronzo e iris o in alternativa da un top in ecoskin e da una struttura in essenza, sulla quale sono poggiati i cuscini disponibili in tutti i tessuti e pelli della collezione Molteni&C.



BALTIMORA —

ISLAND—
EUCALYPTUS
STRUCTURE AND
DRAWERS FRONT,
TRANSPARENT GLASS TOP,
PEWTER COLOUR PROFILES
STRIPE CARPET—

ISOLA—
STRUTTURA E
FRONTALI CASSETTI
EUCALIPTO,
TOP VETRO TRASPARENTE,
PROFILI PELTRO
TAPPETO STRIPE—



505 UP SIDEBOARD

NICOLA GALLIZIA

505 UP Sideboard is the natural evolution of 505 UP in its process of simplification and interpretation of contemporary living requirements. A sideboard with a thousand nuances, like the many variants and combinations of its front pieces. As versatile and functional as 505 UP System but with dedicated depth and a dual option for the base: floor standing plinth, or metal base for a lighter and more aerial version. 505 UP Sideboard experiences the house in all its facets, from living room to dining room, from bedroom to the entrance, the custom solution for every situation and spatial need.

505 UP Sideboard rappresenta la naturale evoluzione di 505 UP nel suo percorso di semplificazione ed interpretazione delle esigenze dell'abitare contemporaneo. Una media dai mille volti, proprio come le innumerevoli varianti e combinazioni delle sue facciate. Versatile e funzionale come 505 UP System ma con una profondità dedicata e una doppia opzione per il basamento: a terra con zoccolo, oppure basamento metallico per una versione più leggera ed aerea. 505 UP Sideboard vive la casa in tutte le sue sfaccettature, dal living alla zona pranzo, dalla camera da letto all'ingresso, la soluzione su misura per ogni situazione ed esigenza di spazio.



505 UP SIDEBOARD —

DOLOMITE GREY MATT
LACQUER STRUCTURE,
"GLAZE" DOORS AND DRAWERS,
ORIENT GREY MARBLE TOP,
PEWTER COLOUR BASE

STRUTTURA
LACCATO OPACO DOLOMITE,
ANTE E CASSETTI "GLAZE",
TOP MARMO GRIGIO ORIENTE,
BASAMENTO PELTRO



505 UP SIDEBOARD —

PINE GREEN MATT LACQUER
STRUCTURE,
3D PINE GREEN MATT LACQUER
DOORS AND DRAWERS,
ORIENT GREY TOP,
PEWTER COLOUR BASE

STRUTTURA
LACCATO OPACO PINE GREEN,
ANTE E CASSETTI
3D LACCATO OPACO PINE GREEN,
TOP MARMO GRIGIO ORIENTE,
BASAMENTO PELTRO





505 UP SIDEBOARD —

SPICE MATT LACQUER
STRUCTURE, TOP,
DOORS AND DRAWERS,
PEWTER COLOUR DRAWERS PROFILE,
PEWTER COLOUR BASE

STRUTTURA,
TOP, ANTE E CASSETTI
LACCATO OPACO SPICE,
PROFILO CASSETTI PELTRO,
BASAMENTO PELTRO



PASS-WORD EVOLUTION

DANTE BONUCCELLI

Pass-Word, the system for both day and night, designed for contemporary homes, is evolving radically to meet new ways of using domestic spaces, marked by the growing presence of multimedia entertainment systems and/or Home Working, alongside the more traditional objects such as books and ornaments. Storage units are moving towards less minimalist forms, with rounded edges for wing or tip-up doors and wood or lacquered drawers, all with flush metal handles. A new vertical open unit has been added to the system to create open spaces alternating with those closed by doors or drawers. Marble, wood or lacquered tops and newly designed metal feet complete the system.

Pass-Word, il sistema per la zona living e la zona notte, progettato per la casa contemporanea si evolve radicalmente per intercettare i nuovi modi di fruizione degli ambienti domestici marcati dalla presenza sempre più massiccia di sistemi multimediali di intrattenimento o relativi all'Home Working, che si affiancano a quelli più tradizionali come libri ed oggetti decorativi. I contenitori si evolvono verso una forma meno minimalista, dotandosi di bordi arrotondati per ante a battente o a ribalta e cassetti in essenza o laccati tutti dotati di maniglia metallica a filo. Un nuovo elemento verticale a giorno viene aggiunto al sistema per creare spazi aperti ad interrompere quelli chiusi da ante o cassetti. Top in marmo, essenza o laccati e piedini metallici di nuovo disegno completano il sistema.



PASS-WORD EVOLUTION —

FLOOR STANDING STORAGE
UNITS WITH PLINTH—
COVERING, HINGED AND FLAP DOORS,
DRAWERS AND TOP EUCALYPTUS,
COPPER MATT LACQUER
OPEN COMPARTMENTS

CONTENITORI
A TERRA CON ZOCCOLO—
RIVESTIMENTO, ANTE BATTENTI, RIBALTA,
CASSETTI E TOP EUCALIPTO,
ELEMENTI A GIORNO
LACCATO OPACO RAME



D.847.1

GIO PONTI

1945 marked the end of the Second World War and the problem of converting war productions into "peace" productions immediately arose in order to restart economic activity. Gio Ponti made contact with an important aircraft manufacturer who owned a factory specialising in the manufacture of gliders. Wood and cloth are, together with great craftsmanship, the most commonly used raw materials. It is, therefore, natural to move into the production of furniture and, as it happens, also wooden toys. In 1947 Gio Ponti designed a "bedroom for a bachelor", presented first at the Galleria del Sagrato, then at the RIMA - Riunione Italiana Mostre per l'Arredamento - at the Triennale, both in Milan, and finally at the XVI International Exhibition in Barcelona in '48. More than 70 years after its original design, the D.847.1 console table is reborn thanks to the Heritage Collection reissue project by Molteni&C, in collaboration with the Gio Ponti Archives. As with all the projects in the Heritage Collection, careful study of drawings, photos and period materials has made it possible to faithfully reproduce the D.847.1 desk in all its details, bringing to light a masterpiece, inspired by the high level of craftsmanship in solid wood processing.

Il 1945 segna la fine del II conflitto mondiale e subito si pone il problema di convertire produzioni belliche in produzioni "di pace" per far ripartire l'attività economica. Gio Ponti entra in contatto con un importante costruttore aeronautico che possiede una fabbrica specializzata in fabbricazione di alianti. Il legno e la tela sono, insieme a una grande capacità artigianale, le materie prime più utilizzate. È naturale, quindi, passare alla produzione di mobili e, guarda caso, anche di giocattoli in legno. Nel 1947 Gio Ponti progetta una "camera da letto per uno scapolo", presentata prima alla Galleria del Sagrato, poi alla RIMA - Riunione Italiana Mostre per l'Arredamento - presso la Triennale, entrambe a Milano, e infine alla XVI Mostra Internazionale di Barcellona nel '48. Dopo oltre 70 anni dal progetto originale, la consolle D.847.1 rinasce grazie al progetto di riedizioni Heritage Collection di Molteni&C, in collaborazione con i Gio Ponti Archives. Come per tutti i progetti della collezione Heritage, lo studio attento di disegni, foto e materiali d'epoca ha permesso di riprodurre fedelmente lo scrittoio D.847.1 in tutti i dettagli, riportando alla luce un capolavoro, dettato dall'alta artigianalità della lavorazione del massello.

HERITAGE COLLECTION





D.847.1 —

WRITING DESK—
HONEY STAINED ASH WOOD,
SATIN BRASS FEET,
DRAWER SLIDE
ON WOODEN RUNNERS
VIBRAZIONI CARPET—

SCRITTOIO—
FRASSINO TINTO MIELE,
PIEDI OTTONE SATINATO,
CASSETTO
SU GUIDE DI LEGNO
TAPPETO VIBRAZIONI—

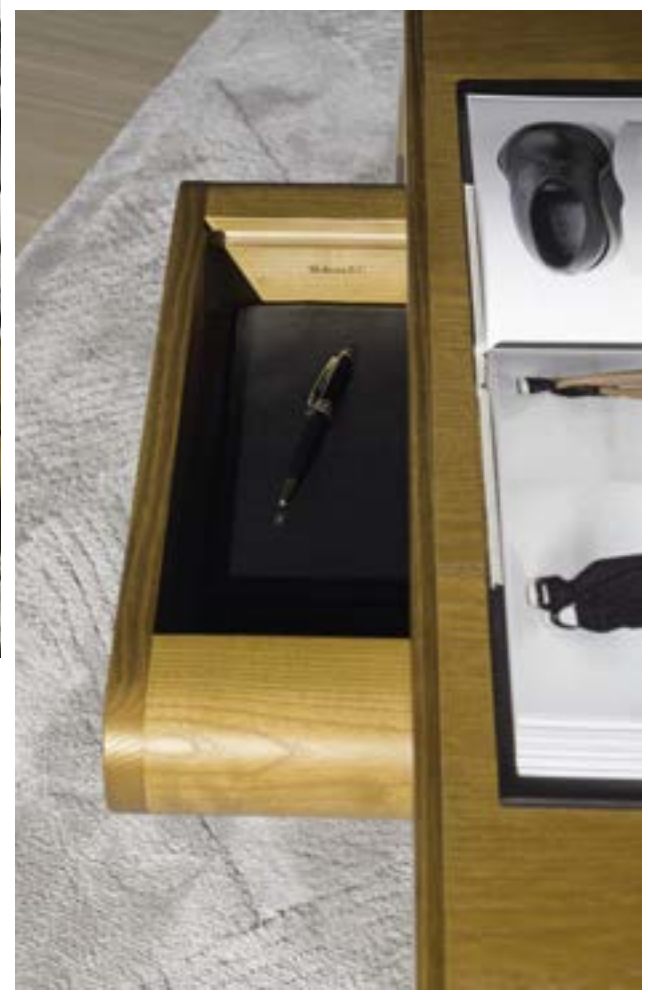

NOTE

MATTEO NUNZIATI

This desk is the result of the desire to create a contemporary product with essential characteristics and very refined aesthetic and technical details that demonstrate the woodworking expertise that Molteni&C. is devoted to maintaining. The top, positioned asymmetrically on the structure, has two trays carved into its wood surface, and the central tray is covered in hide leather. The wood on the rear is made with a pronounced curved shape that allows it to hold small drawers, which are also covered in hide leather. The legs are made with a complex three-dimensional woodworking technique in which grooves are carved into three sides of the piece. The resulting product shows a good balance of essential style and elegance, simultaneously modern and linear while also refined and rich in expert cabinet-making details.

Il progetto nasce dalla volontà di creare un prodotto contemporaneo ma essenziale, molto ricercato nei dettagli estetici e tecnici, che esaltano tutta la maestria della lavorazione del legno tanto cara a Molteni&C. Il piano di scrittura, posizionato asimmetricamente, rispetto alla struttura, è dotato di due vassoi scavati direttamente nel piano stesso, di cui quello centrale ha un rivestimento in cuoio. La parte posteriore è caratterizzata da un pronunciata curvatura del legno che permette l'alloggiamento di piccoli cassetti rivestiti anch'essi in cuoio. Le gambe, realizzate grazie ad una complessa tecnica di lavorazione tridimensionale del legno, sono scavate su tre lati. Il risultato è un prodotto in equilibrio tra essenzialità ed eleganza, un prodotto moderno e lineare ma allo stesso tempo raffinato e ricco di dettagli di alta ebanisteria.



SCRIBA

PATRICIA URQUIOLA

A writing desk with very clean lines and a decoratively perforated top support element that conveys a sense of lightness. Wood tops, a practical side drawer, a clever bookshelf support element in lacquered sheet metal and a side pouch in hide leather complete the desk.

Uno scrittoio dalle nitide linee dove, l'elemento di sostegno del piano di scrittura, si caratterizza per la leggerezza data dal decoro traforato. Piani in legno, un pratico cassetto laterale, un ingegnoso supporto reggilibri in lamiera laccata e una bisaccia laterale in cuoio completano lo scrittoio.



SCRIBA —

WRITING DESK—
EUCALYPTUS,
DOLOMITE GREY MATT LACQUER
MHC.3 MISS CHAIR—
HEM CARPET—

SCRITTOIO—
EUCALIPTO,
LACCATO OPACO DOLOMITE
SEDA MHC.3 MISS—
TAPPETO HEM—



D.950.1

GIO PONTI

Framed mirrors designed in 1950 in three several sizes. Cornici con specchio disegnate nel 1950 in tre diverse dimensioni. Sono realizzate in massello verniciato a mano in colore bianco.

HERITA-
GE COL-
LECTION

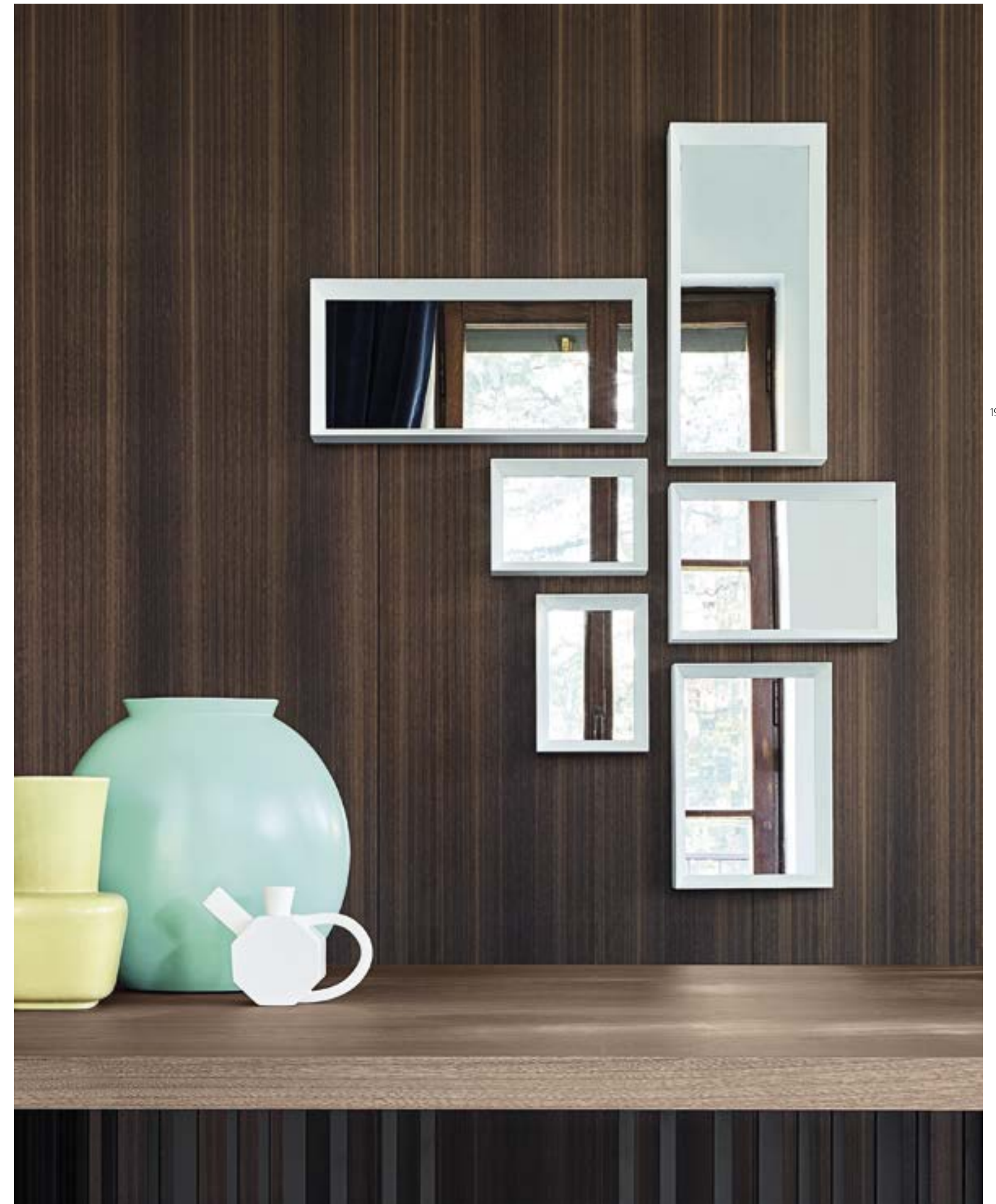
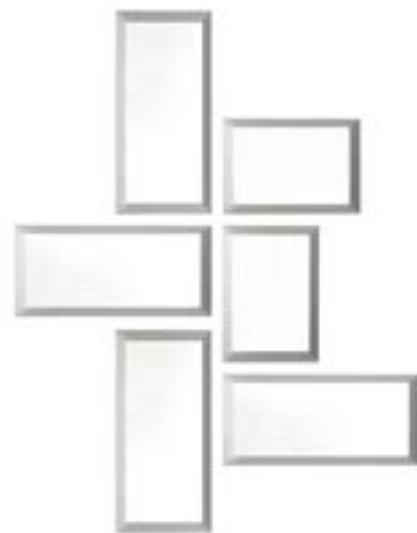

HECTOR MIRROR

VINCENT VAN DUYSSEN

From the stylistic line of the Hector night system comes Hector Mirror, a mirror dictated by extreme minimalism. Hector Mirror can be hung on the wall or placed on the floor, available in bronze and pewter colour finishes with an aluminium frame. With its contemporary character, it fits into any environment, from the living to the sleeping area.

Dalla linea stilistica del sistema notte Hector nasce Hector Mirror, uno specchio dettato dal minimalismo estremo. Hector Mirror può essere appeso a parete o appoggiato a terra, declinato nelle finiture bronzo e peltro con telaio in alluminio. Con il suo carattere contemporaneo, si posiziona in ogni ambiente, dal living alla zona notte.



SEASONS COLLECTION

MEYER

BOUCLÉ COLLECTION

BOUCLÉ

GEA COLLECTION

SABLE

SOFT

PLUSH COLLECTION

PLUSH CASHMERE

LIM COLLECTION

LIM

TRAMA COLLECTION

SAND

SAINT CLOUD

TARASCONA

VERSAILLES

bed set
bed accessories

194 | 195



MEYER BLANKET

Seasons Collection

by IVANOREDAELLI®

100%
MADE
IN
ITALY

Meyer, a blanket in fine cashmere worked on a loom is finished with hand-frayed fringe. Available in four colorways, it perfectly matches the linen bedding, creating an ensemble of refined harmony.

Meyer, una coperta in pregiato cashmere lavorato a telaio con finitura a frange sfilate a mano. Disponibile in quattro varianti colore, si abbina perfettamente al completo letto in lino creando un ensemble di ricercata armonia.



Typology:
100% cachemire
Washing: dry-clean

Finishes:
processing on frame
with fringe finish
pulled by hand

Tipologia:
100% cachemire
Lavaggio: secco

Finiture:
lavorazione su telaio
con finitura frangia
sfilata a mano

MEYER BLANKET
150x220 cm



SPRING



SUMMER



AUTUMN



WINTER



BOUCLÉ PLAID

Bouclé Collection

MARTA FERRI

100%
MADE
IN
ITALY

A wool, silk and cashmere blanket made with a particular bouclé weave, which gives it a wavy and elaborate appearance. The silk fibre lends a subtle sheen, while the cashmere guarantees softness. A truly special textile item further enriched by an all-round fringed border on the short side. Developed in a warm brown shade that contrasts with the more summery navy blue, as well as with the natural variant perfectly contextualized in every setting.

Coperta in lana, seta e cashmere realizzata con una particolare armatura bouclé, che le dona un aspetto mosso ed elaborato. La fibra in seta le attribuisce una leggera lucentezza, mentre il cashmere presente ne garantisce la morbidezza. Un oggetto tessile davvero particolare arricchito ulteriormente da una bordatura con frange presente sul lato corto. Sviluppata in un tono caldo marrone a contrasto con quello più estivo blu navy, oltre che alla variante naturale perfettamente contestualizzata in ogni ambiente.



BOUCLÉ PLAID
140x240 cm



OFF WHITE



BORDEAUX

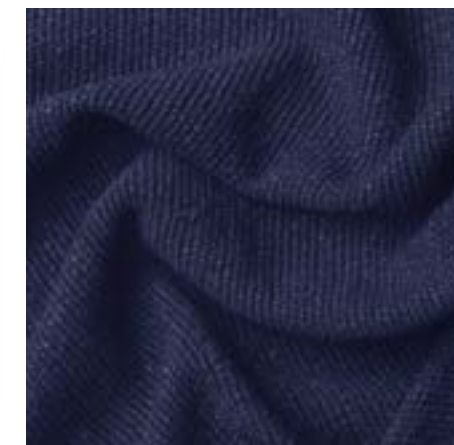

DEEP BLUE

Tipologia:
87% wool 9% silk
4% cashmere
Weight gm²: 410

Washing: dry-clean
Finishes: fringe 5 cm

Tipologia:
87%lana 9% seta
4% cashmere
Peso gm²: 410

Lavaggio: secco
Finiture: frangia 5 cm



SABLE PLAID

Gea Collection

MARTA FERRI

100%
MADE
IN
ITALY

The "Gea Collection" starts two plaids in cashmere, merino nuanced wool finished with blanket stitch. A new world to dress the Molteni&C collection beds, 100% made in Italy, using the finest yarns with a contemporary image.

La collezione "Gea Collection" vede protagonisti due plaid in cashmere, lana merino sfumata e con bordi in punto cavallo. Un nuovo mondo per vestire i letti della collezione Molteni&C, 100% made in Italy, con l'utilizzo dei più pregiati filati e dall'immagine contemporanea.



SABLE PLAID
140x230 cm



HAZELNUT



BEIGE



OLIVE

Typology:
100% cashmere
Weight gm²: 255
Washing: dry-clean

Finishes:
tartan with bias fringe
on the short side and
selvedge finish on the
long side, fringe 7 cm

Tipologia:
100% cashmere
Peso gm²: 255
Lavaggio: secco

Finiture:
plaid con penero su lato
corto e falso splitz su lato
lungo, frangia 7 cm



SOFT PLAID

Gea Collection

MARTA FERRI

100%
MADE
IN
ITALY

This ultra light imperceptible yarn is the result of a careful selection of the most precious Australian merino wool fibre on the market. The rigorous choice of 16.5 micron raw material, guaranteed by long-standing relations with our suppliers, along with the professional care given to processing yield an ultra fine and inter seasonal yarn. Its excellent quality has won it the 140's Woolmark Company (international certification agency for pure wool) certificate in the 2/60 titre category, indicating the fineness of the fibre, precisely 16.5 micron.

Questo filato leggerissimo e impalpabile è frutto di un'attenta selezione di fibre della più pregiata lana merino australiana disponibile sul mercato. La rigorosa selezione della materia prima di 16.5 micron, garantita dallo storico rapporto con i nostri fornitori, affiancata alla cura professionale nella lavorazione danno vita ad un filato sottilissimo ed interstagionale. L'altissimo pregio gli ha valso nel titolo 2/60 il certificato 140's Woolmark Company (l'Ente internazionale di certificazione della pura lana vergine) che indica la finezza della fibra, per l'appunto i 16.5 micron.



Typology:
100% merino wool
Weight gm²: 180
Washing: dry-clean

Finishes:
shaded tartan with
hem on the long side
and blanket stitch finish
on the short side

Tipologia:
100% lana merino
Peso gm²: 180
Lavaggio: secco

Finiture:
plaid sfumato orlato
su lato lungo
e finito punto cavallo
su lato corto

SOFT PLAID
140x250
CUSHION
50x50 cm



RUST



OLIVE



DOLOMITE



MUSTARD



PLUSH CASHMERE PLAID

Plush Collection

NICOLA GALLIZIA

100%
MADE
IN
ITALY

An elegant blanket, with a cosy enveloping feel and look. Weft and warp create a rich, soft structure enriched by a sophisticated detail of tone-on-tone blanket stitching round the edge, reminiscent of sartorial excellence. Plush is a multi-purpose accessory that can enrich a bedroom but also a living room with a note of refined colour. The colour range reflects accents of the Molteni style.

Una materia elegante, avvolgente al tatto e alla vista. Trama e ordito creano una struttura ricca e morbida arricchita da un sofisticato dettaglio di orlatura a punto cavallo in tono su tono che rimanda alla alta sartorialità. Plush è un accessorio trasversale che può arricchire una zona notte ma anche un soggiorno con una nota di raffinato calore. La gamma colori segue accenti dello stile Molteni&C.



PLUSH CASHMERE PLAID
140X180 cm - 140X240 cm



OFF WHITE



LIGHT GREY



MALACHITE GREEN



Tipologia:
100% cashmere
Weight gm²: 215

Washing: dry-clean

Tipologia:
100% cashmere
Peso gm²: 215

Lavaggio: secco



SAND PLAID
Trama Collection
MARTA FERRI

100%
MADE
IN
ITALY

Completing the textile range, a choice of accessories, blankets and bedding coordinates, to enrich the Molteni&C bed collection. For blankets, in the winter version, the range includes double wool with nubuk edging in warm dove grey and browns. The offering is completed with a summer version in fresh, reassuring colours.

A completamento delle proposte tessili, si affianca un'offerta di accessori, coperte e coordinati notte, per arricchire la collezione letti Molteni&C. Per le coperte, nella versione notturna invernale, viene proposta la lana doppiata con un bordo in nabuk nei colori caldi dei tortora e marroni. L'offerta si completa con una versione estiva dai toni freschi e rassicuranti.



SAND PLAID
240x240 cm



DOVE GREY



ASH GREY

Typology:
border made of nubuck
leather and central part
made of wool

Washing: dry-clean

Tipologia:
bordo in pelle nabuk
con parte centrale
in lana

Lavaggio: secco



LIM BED LINEN

Lim Collection

by IVANOREDAELLI®

100%
MADE
IN
ITALY

In 2024, the Molteni&C bed is enriched with new additions that include a set of sheets, pillowcases and a duvet cover embellished with a delicate embroidery in natural tones. The linen, dyed in the piece, guarantees a feeling of freshness and wellbeing during sleep.

Nel 2024 il letto Molteni&C si arricchisce di nuovi complementi che includono un set di lenzuola, federe e copripiumone impreziositi da un delicato ricamo dai toni naturali. Il lino, tinto in pezza, garantisce una sensazione di freschezza e benessere durante il sonno.

LIM

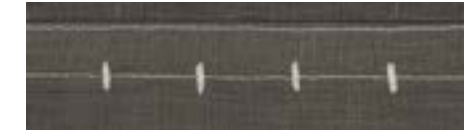

ANTHRACITE / WHITE

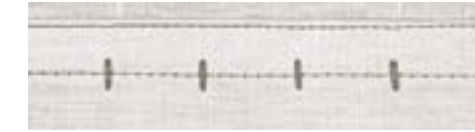

IVORY / ECRU

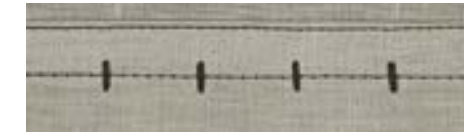

ECRU / BLACK

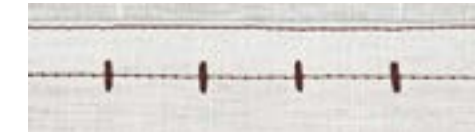

WHITE / OPIUM



Typology:
100% piece-dyed linen
Machine
embroidered

Duvet cover set:
Duvet cover
2 pillowcases
Bottom sheet

Tipologia:
100% lino tinto in pezza
Ricamo realizzato a
macchina

Set copripiumone:
Copripiumone
2 federe
Lenzuolo sotto

Complete set:
Top sheet
2 pillowcases
Bottom sheet

Additional accessories:
Extra pillowcases
Bag without embroidery,
plain colour

Set completo:
Lenzuolo sopra
2 federe
Lenzuolo sotto

Accessori aggiuntivi:
Federe extra
Sacco senza ricamo,
tinta unita



TARASCONA, VERSAILLES, SAINT CLOUD

Trama Collection

MARTA FERRI

100%
MADE
IN
ITALY

Tarascona 100% linen made with yarn bearing the Master of linen guarantee, which certifies the origin of Normandy's raw material.

Versailles 100% Egyptian yarn, made with compact soft-touch cotton, which prevents pilling. The special finish gives the product a silky feel.

Saint Cloud superior 100% Egyptian cotton, combines the freshness and versatility of cotton with the sheen usually associated with silk.

Tarascona Tessuto 100% lino realizzato con filato Master of linen, ente che certifica la provenienza della materia prima dalla Normandia.

Versailles 100% filato egiziano, realizzato con cotone compact, che conferisce al tessuto mano morbida evitando la formazione di pilling. Finissaggio speciale che conferisce al prodotto un effetto setoso.

Saint Cloud superiore Cotone 100% egiziano, unisce la freschezza e versatilità del cotone alla lucentezza tipica solitamente della seta.

TARASCONA



SALT



CHALK



ROPE



SAND



MOTHER OF PEARL



SUEDE

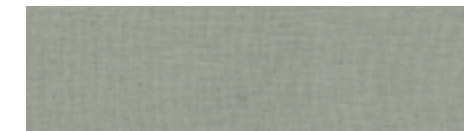

SLATE GREY



KALA NAMAK



Typology:
100% linen
Washing: 40°

Summer bed set
Duvet cover set
Quilt with 3
quilted flounces
Hemstitch 4 ruffles
Mitre corners

Tipologia:
100% lino
Lavaggio: 40°

Completo letto estivo
Set copripiumino
Trapunta impunturata
con 3 volani trapuntati
Orlo a giorno 4 volani
Angoli a cappuccio



VERSAILLES

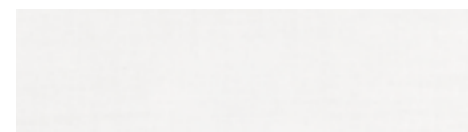

SALT

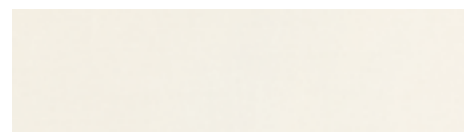

CHALK

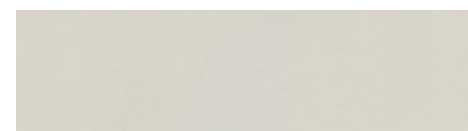

MOTHER OF PEARL

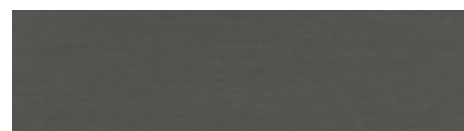

ASH GREY



KALA / NAMAQ

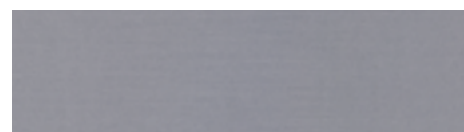

STEEL



RABBIT



IRON



Typology:
100% cotton
Washing: 40°

Summer bed set
Duvet cover set
Quilt with
3 quilted flounces
Plain hem 4 ruffles
Mitred corners

Tipologia:
100% cotone
Lavaggio: 40°

Completo letto estivo
Set copripiumino
Trapunta impunturata
con 3 volani trapuntati
Orlo semplice 4 volani
Angoli a cappuccio

SAINT CLOUD SUPERIOR

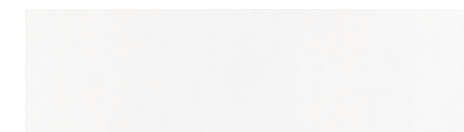

SALT

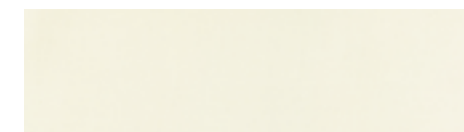

CHALK

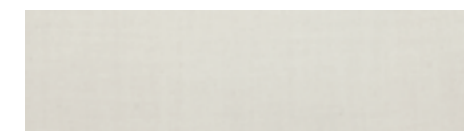

MOTHER OF PEARL

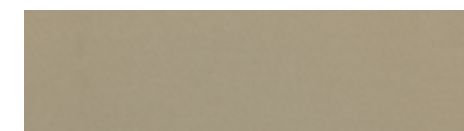

RABBIT

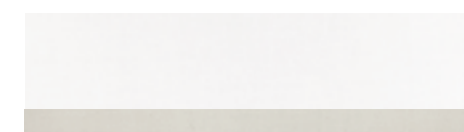

SALT / MOTHER OF PEARL



SALT / LAPILLO

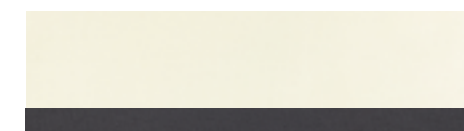

CHALK / IRON



CHALK / TERRACOTTA



Typology:
100% cotton
Washing: 40°

Summer bed set
Duvet cover set
Tone-on-tone
piping or contrasting
colour piping 4 ruffles
Mitred corners

Tipologia:
100% cotone
Lavaggio: 40°

Completo letto estivo
Set copripiumino
Piping tono su tono
o a contrasto 4 volani
Angoli a cappuccio



BED ACCESSORIES ACCESSORI LETTO

Choosing a bed system that is ecological, built with natural materials with a modern and functional design, with which to match bedsprings and mattresses and accessories with the same characteristics, is essential for a rest able to make the most of the relaxing and regenerating energy of our body. Molteni&C offers a complete line of accessories with natural, ecological features. Mattresses, pillows, toppers, eiderdown duvets and pure cotton linens are part of this new collection.

Scegliere il sistema letto, ecologico, costruito con materiali naturali dal design moderno e funzionale, a cui abbinare reti e materassi ed accessori con le stesse caratteristiche, è essenziale per un riposo capace di sfruttare le energie rilassanti e rigeneranti del nostro corpo. Molteni&C propone una linea completa di accessori dalle caratteristiche naturali ed ecologiche. Materassi, guanciali, topper, piumini e biancheria in puro cotone fanno parte di questa nuova collezione.

PILLOWS / GUANCIALI



MATTRESSES / MATERASSI

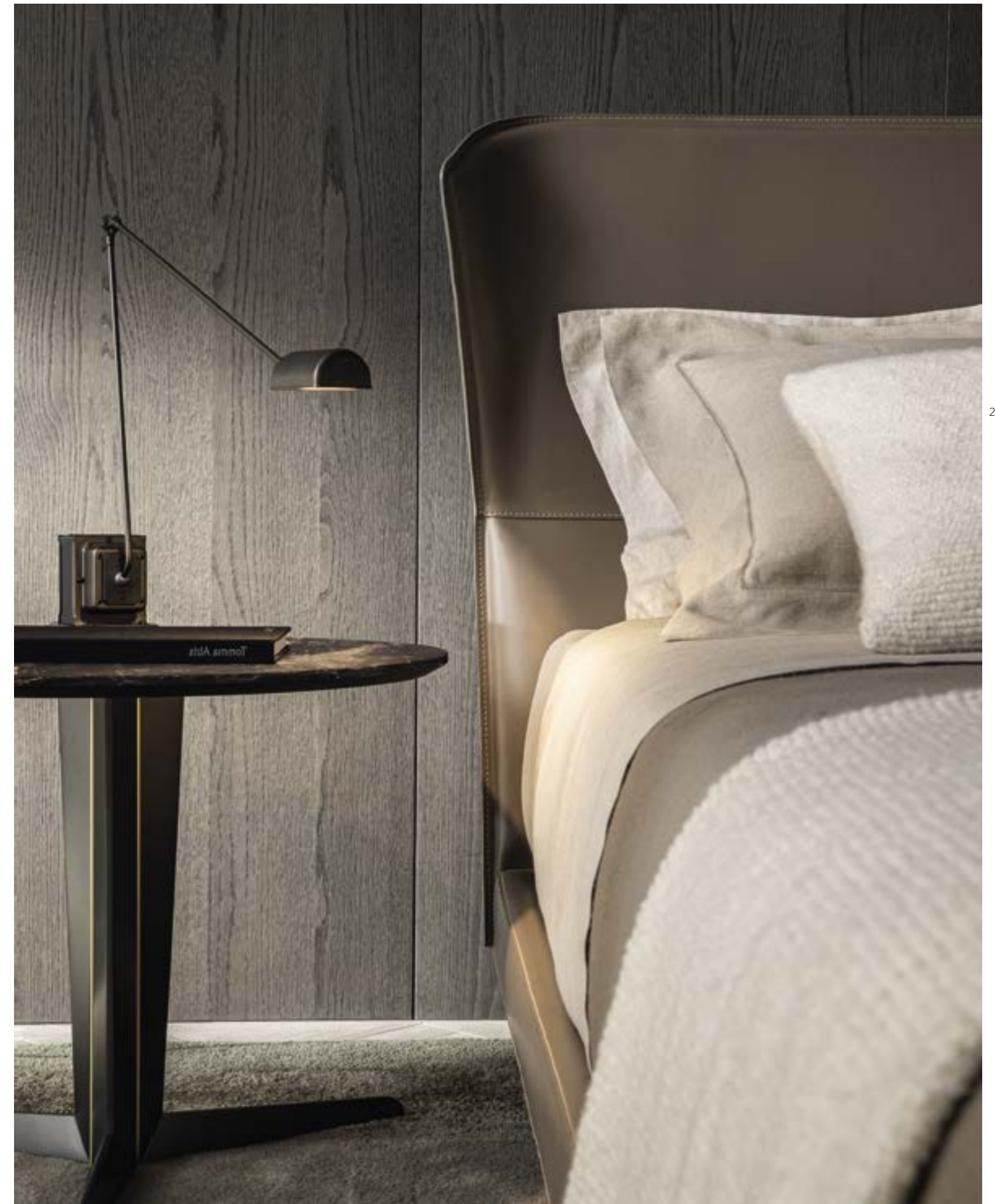

PILLOWS, DUVETS AND TOPPERS GUANCIALI, PIUMINI, TOPPERS

PILLOWS

Only natural fibers for the pillows: goose feathers, linen or cotton always enclosed in cotton pillow cases. The fillings are always encased in individual sections and help to keep the head in the correct sleeping position.

DUVETS

The Hungarian goose down filling (g sq m 190+130) moulds softly around the body, keeping it at an optimal temperature. Encased in individual sections, the filling stays in place, spreading warmth evenly. The duvets are machine washable using a delicate program.

TOPPERS

A new way of sleeping that combines softness with the necessary support provided by the mattress. Placed over the mattress, the topper protects it and increases its height, gently accommodating the body shape. 100% feathers in individual sections.

GUANCIALI

Solo fibre naturali per i guanciali: piuma d'oca, lino o cotone in falda sempre racchiusi in fodere di cotone. Le imbottiture sono disposte in scompartimenti indipendenti e aiutano a mantenere le corrette posizioni del sonno.

PIUMINI

I piumini di piume d'oca ungherese (gr mq 190+130), abbracciano il corpo morbidamente e aiutano a custodire la temperatura corporea ottimale. Scompartimenti indipendenti evitano lo spostamento delle piume. Possono essere lavati in lavatrice utilizzando un programma delicato.

TOPPERS

Il nuovo modo di dormire che unisce morbidezza al necessario supporto fornito dal materasso. Sovrapposto al materasso lo protegge e ne aumenta l'altezza, accogliendo morbidamente il profilo del corpo. 100% in piuma a scompartimenti indipendenti.



MATTRESSES MATERASSI

To meet diverse needs and habits, the mattresses come in different versions and in different thicknesses. All the materials used are natural and anallergic, with easy-wash unzippable natural wood fiber mattress covers.

Per soddisfare le diverse esigenze ed abitudini, i materassi sono disponibili in diverse versioni e altezze. Tutti i materiali impiegati sono naturali ed anallergici, con fodera in fibra di legno naturale facilmente lavabile grazie ad un semplice sistema di cerniera.

Orthopaedic spring

H 200 (7 7/8") - H 250 (9 7/8")

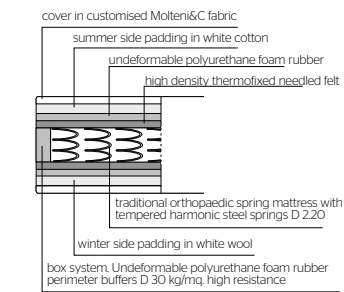

7-Zone independent spring

H 250 (9 7/8")

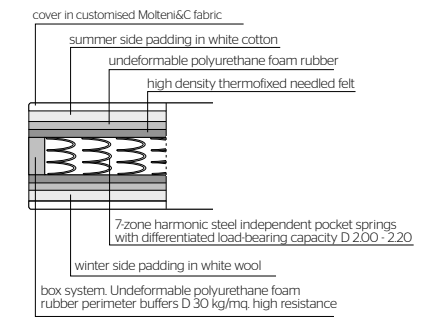

Ecomemory

H 200 (7 7/8")

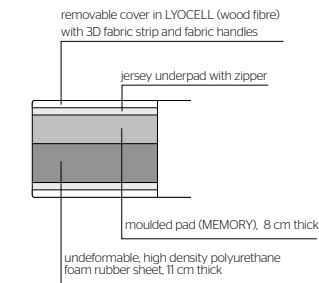

7-Zone latex

H 200 (7 7/8")

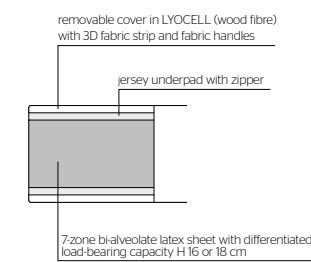

7-Zone independent spring

H 200 (7 7/8") - H 250 (9 7/8") "Nature series"

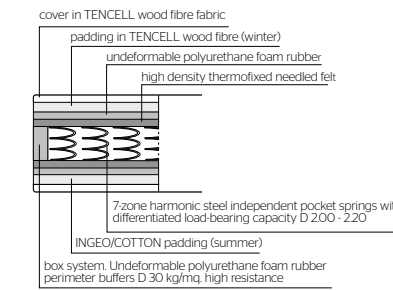

D.754.1
ATALANTE
AURA
DEDALO
DUNA
EDGE
EONE
HEM
PALETTE
RANDOM
SONORO
STRIPE
TELARO
VIBRAZIONI

carpet collection



218 | 219



D.754.1

GIO PONTI

Rug of an unusual geometric form, designed in 1954, as a prototype, for the Ponti's house on via Dezza in Milan. Made of "Pony" leather in four colours: white, brown, black, beige.

Tappeto dall'insolita forma geometrica, disegnato nel 1954 come prototipo per la casa Ponti di via Dezza a Milano. Realizzato in pelle di cavallino a quattro colori: bianco, marrone, nero, beige.



WHITE



BLACK



BROWN



BEIGE

Dimensions / Dimensioni
240 x 245 cm

Pony leather

Pelle di cavallino



ATALANTE by Ruckstuhl

NICOLA GALLIZIA

Natural hemp fibres, hand woven according to ancient carpet weaving techniques, feature geometric surfaces of simple and elegant modernity. Distinct backgrounds, modulated like a musical score, become delightful decorative motifs in the material and in the natural colour combinations.

La fibra naturale di canapa, tessuta a mano secondo antiche tecniche del tappeto intrecciato, disegnano superfici geometriche di semplice ed elegante modernità. Campiture nette, ritmate come una partitura musicale, diventano motivo decorativo che trova la sua preziosità nella materia e nella naturalezza degli abbinamenti cromatici.



DESERT



VULCANO



LAVA

Dimensions / Dimensioni

300 x 200 cm

300 x 300 cm

400 x 300 cm

500 x 400 cm

Hand-tufted

Height fleece 12 mm

100% Hemp

Taftato a mano

Spessore 12 mm

100% Canapa



AURA

NICOLA GALLIZIA

Aura, designed in Italy by Nicola Gallizia for Molteni&C, is a rug produced in the Kathmandu valley in Nepal. The glossy and matt effects achieved by using vegetable silk and wool, which respond differently to the light, produce a refined and subtle monochromatic finish. The border, skillfully finished with scissors, completes the rug and adds a touch of elegance. The entire rug production process is performed by hand, from carding the raw materials to weaving right through to finishing.

Aura firmato da Nicola Gallizia per Molteni&C è un tappeto disegnato in Italia e prodotto nella valle di Kathmandu, Nepal. Gli effetti lucido ed opaco, dati dal contrasto seta vegetale e lana, restituiscono un comportamento diverso alla luce, che rende percepibile la raffinatezza del contrasto monocromatico. La bordura maestralmente realizzata a forbice in fase di finissaggio, completa il tappeto e aggiunge un tocco di eleganza. L'intero processo di produzione del tappeto viene realizzato a mano.



ANTHRACITE



BORDEAUX



JADE

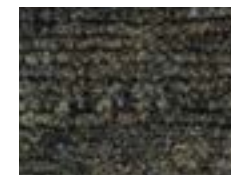

PETROLEUM BLUE



SAGE

	Hand Loom	Telaio a mano
	Height fleece 6 mm	Spessore vello 6 mm
	Height border 3 mm	Spessore bordura 3 mm
Dimensions / Dimensioni	Ngari wool pile	Vello in lana Ngari
300 x 100 cm	rug with a Tibetan wool	e un twill di lana
300 x 250 cm	and viscose	tibetana e viscosa
400 x 300 cm	(or bamboo silk) twill	(o seta vegetale)
Ø 300 cm		



DEDALO by Pierre Frey

MARTA FERRI

The Dedalo rug is characterised by a rigorous geometry and refined colours that are always the protagonists of the design, harmoniously integrating in the new everyday concept of the home. The project marks the first collaboration with the prestigious Maison Pierre Frey which, with over eighty years of experience, is a leader in the production of wonderful fabrics for curtains and upholstery. The exceptional know-how of Maison Pierre Frey thus combines with Molteni&C's obsession for quality and detail to create a project with an innovative design and strong visual impact.

Dedalo si caratterizza per una geometria rigorosa e da cromie ricercate e sempre protagoniste nel progetto, in grado di integrarsi con armonia al nuovo concetto quotidiano di casa. Il progetto segna una prima collaborazione con la prestigiosa Maison Pierre Frey che, con oltre ottanta anni di storia, è leader nella produzione di meravigliosi tessuti per tendaggi e imbottiti. L'eccezionale know-how della Maison Pierre Frey si unisce così all'ossessione per la qualità e per i dettagli di Molteni&C nella creazione di un progetto innovativo nel design e dal forte impatto visivo.



ORANGE SPARK



SOFT GREY

Dimensions / Dimensioni

400 x 200 cm
300 x 300 cm
400 x 300 cm
500 x 300 cm

Hand-tufted with carving
Height fleece 15 mm
70% Tencel
30% Wool

Taftato a mano con carving
Spessore 15 mm
70% Tencel
30% Lana



DUNA

NICOLA GALLIZIA

Inspired by the geometric impermanence of the desert dunes, Duna is made of wool and bamboo platted in various thicknesses to produce the effect of furrows of sand. Its modularity gives rise to an elegant and simple decorative effect. Handcrafted using the manual tufting method, Duna is available in three versions of warm and natural colors: Ivory, Tobacco and Anthracite.

Ispirato all'impermanenza geometrica delle dune del deserto, Duna è realizzato in lana e bambù intrecciati in vari spessori per produrre l'effetto dei solchi di sabbia. La ripartizione in moduli dà vita ad un effetto decorativo all'insegna dell'eleganza e della semplicità. Realizzato artigianalmente con metodo tufting manuale, Duna è disponibile in tre versioni di colori naturali ed accoglienti: Ivory, Tobacco e Anthracite.



ANTHRACITE



TOBACCO



IVORY

Dimensions / Dimensioni
400 x 200 cm
300 x 300 cm
400 x 300 cm
500 x 300 cm

Hand-tufted
Height fleece 12 mm
Density 5 kg/mq
75% New Zeland Wool
25% Bamboo

Taftato a mano
Spessore 12 mm
Peso 5 kg/mq
75% New Zeland Wool
25% Bamboo



EDGE

NICOLA GALLIZIA

Wool and linen, materials from the most sophisticated tradition of carpet manufacturing, mixed in a new way for a new soft and bright feel. The conventional edge of the carpet, which frames the central field, reinvents the decoration using the colours of our memory. It is a return to simple and elegant chromatic lines.

Lana e lino, materia della più sofisticata tradizione del tappeto, mescolate in maniera nuova diventano una inedita superficie morbida e luminosa. Il tradizionale bordo del tappeto che riquadra la campitura centrale, reinventa la decorazione utilizzando colori della memoria riportandola a segno grafico e cromatico semplice ed elegante.



BLUE GRADIENT BORDER



BROWN GRADIENT BORDER



GREEN GRADIENT BORDER



MOON GRADIENT BORDER



ROSE GRADIENT BORDER

Dimensions / Dimensioni	Hand-tufted	Taftato a mano
300 x 300 cm	Height fleece 18 mm	Spessore 18 mm
400 x 300 cm	Gradient border 40 cm	Gradiente bordo 40 cm
500 x 300 cm	80% Mohair wool	80% Lana mohair
Ø 500 cm	20% Linen	20% Lino



EONE

NICOLA GALLIZIA

Eone offers a luxurious long-pile rug that enchants with its tactile allure and creates an irresistibly inviting ambiance. Crafted exclusively from 100% bamboo yarn, renowned for its refreshing qualities and minimal ecological footprint, Eone delivers a sensorial experience like no other.

Eone offre una raffinata opzione di tappeto a pelo lungo, piacevole al tatto in ogni stagione e apprezzato per l'irresistibile atmosfera di accoglienza che sa creare. La sensoriale esperienza tattile di questo tappeto è resa possibile grazie al filato esclusivamente in bambù al 100%, una materia prima nota per le sue qualità di freschezza e sempre più ricercata per il suo ridotto impatto ecologico.



SAND



BARK



IVORY



EBONY

Dimensions / Dimensioni

400 x 200 cm

400 x 300 cm

500 x 400 cm

Custom / Su misura

Hand-tufted

Height fleece 3 cm

Density 5,5 kg/mq

100% Bamboo

Taftato a mano

Spessore 3 cm

Densità 5,5 kg/mq

100% Bamboo



HEM by G.T.Design

PATRICIA URQUIOLA

Rugs return to their original purpose as islands or places where people sit down together and forget their daily worries. Always different, they express a blend of the highest western creativity and ancient Asian craft traditions. From the long-standing partnership between Molteni&C and Patricia Urquiola, a new family of products. This combination uses natural materials to create a harmonious rug collection.

Il tappeto ritorna all'antica funzione di isola, dove ritrovarsi e dimenticare gli affanni quotidiani. Sempre diverso, perché frutto dell'incontro tra la più alta creatività occidentale e la millenaria artigianalità asiatica. La lunga collaborazione tra Molteni&C e Patricia Urquiola si arricchisce di una nuova famiglia di prodotti. Ed è proprio questo incontro, unito a materiali naturali a dar vita a una collezione di tappeti di grande armonia.



STONE



SAND

Dimensions / Dimensioni	Hand knotted	Realizzati a mano
300 x 250 cm	Height fleece 6 mm	Spessore 6 mm
400 x 300 cm	Density	Densità
Ø 250 cm	86.000 knots/mq	86.000 nodi/mq
	100% Bamboo silk	100% Bamboo silk



PALETTE

NICOLA GALLIZIA

A collection consisting of matter and colour, the decorative peculiarity of these carpets is their essential elegance. The vibrato depth of colour creates a soft and enveloping effect that functions as ordering element of space.

È una collezione costruita di materia e colore, cifra decorativa di questi tappeti eleganti proprio perché essenziali. Il vibrato del colore crea un effetto morbido e avvolgente che accoglie e diventa elemento ordinatore dello spazio.



CREAM



DOVE GREY



ANTHRACITE



TAUPE



BORDEAUX



PETROLEUM BLUE

Dimensions / Dimensioni

300 x 300 cm

Hand-tufted

Taftato a mano

400 x 300 cm

Height fleece 18 mm

Spessore 18 mm

500 x 300 cm

100% Tencel

100% Tencel



RANDOM by Altai

PATRICIA URQUIOLA

The charm of an ancient rug, with its marked individuality and well-worn look, is the source of inspiration for Random. The well-worn look is the key feature, expressing itself in an original exaltation of the texture of the rug, created with an innovative hand-woven technique, which highlights the structure of the weave.

Il fascino del tappeto antico con la sua spiccata individualità e il suo aspetto vissuto è la fonte di ispirazione che ha portato alla creazione di Random. Il vissuto a cui si ispira, diventa l'elemento caratterizzante esprimendosi in una originale esaltazione della trama del tappeto creata attraverso una innovativa tecnica di lavorazione a mano che mette in rilievo la struttura del tessuto.



ARTIC



PLATINUM



POWDER PINK

	Hand knotted	Annodato a mano
	Height fleece 12/14 mm	Spessore 12/14 mm
	Density	Densità
Dimensions / Dimensioni	40.000 knots/mq	40.000 nodi/mq
300 x 200 cm	80 % Bamboo silk,	80% Bamboo silk,
400 x 300 cm	10 % Cotton, 10% Wool	10% Cotone, 10% Lana
Ø 300 cm	Backing: natural latex	Appoggio: lattice naturale



SONORO

NICOLA GALLIZIA

Fashioned from wool yarn and cotton, it boasts a luxuriously soft and inviting texture, perfectly suited for a variety of indoor environments. Sonoro captivates with its intricate pattern of slender rectangles, reminiscent of gracefully dancing piano keys. In the monochromatic rendition, the key illusion is heightened by the meticulous alignment and alternating knot directions during the loom process, resulting in varied pile heights and a mesmerizing interplay of light and shadow. Meanwhile, the two-tone version accentuates the decorative allure through a harmonious color contrast.

Realizzato in pregiato filato di lana e cotone, questo tappeto offre una mano morbida e avvolgente, risultando ideale per svariate ambientazioni interne. Sonoro si distingue per la sua caratteristica trama di sottili rettangoli sullo sfondo, evocando l'immagine di tasti di pianoforte che danzano in armonia. Nella versione monocromatica, la sensazione dei tasti è sottolineata dalla particolare inclinazione e cambio di direzione dei nodi durante la lavorazione su telaio, generando una variazione di altezze del pelo e un affascinante gioco di riflessi alla luce. La versione bicolore, invece, enfatizza ulteriormente l'effetto decorativo attraverso il contrasto cromatico scelto.

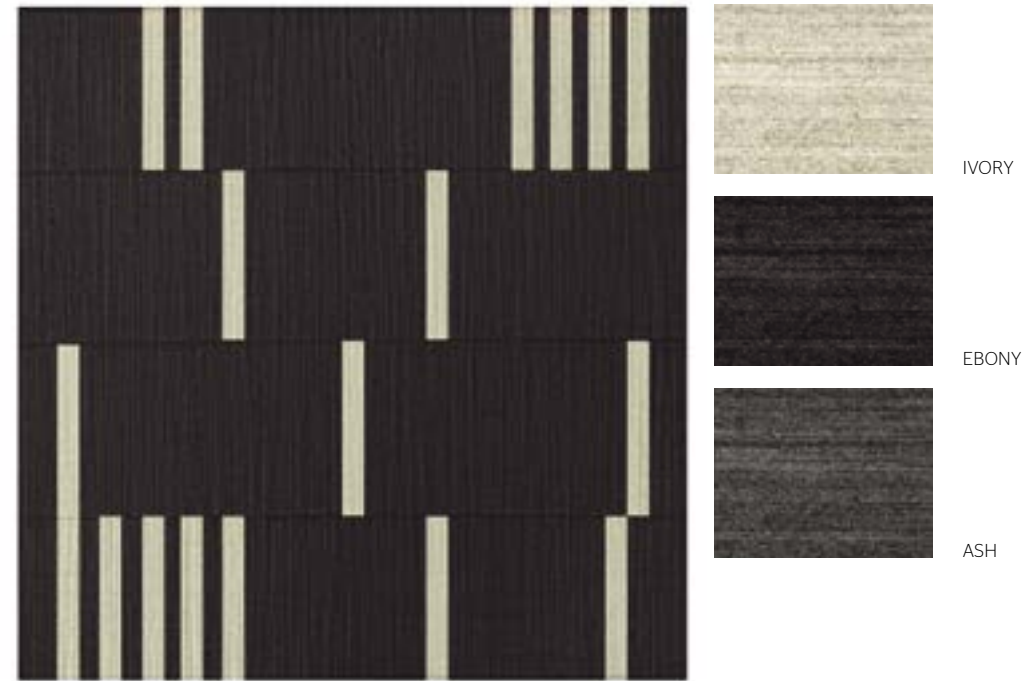

Dimensions / Dimensioni

300 x 200 cm	Hand-woven on loom	Tessuto a mano su telaio
400 x 300 cm	Height fleece 0,6/0,8 cm	Spessore 0,6/0,8 cm
400 x 400 cm	Density 3 kg/mq	Peso 3 kg/mq
500 x 400 cm	80% Wool	80% Lana
Custom / Su misura	20% Cotton	20% Cotone



STRIPE

VINCENT VAN DUYSSEN

The sophisticated beauty of these soft surfaces is the result of a deliberate contrast between the simplicity of the design and decorative detail and the richness of the material. Slender alternating stripes of wool and silk create geometric backgrounds in shades of tone-on-tone colours that delicately reflect the light. Harmonious balance between rigour and form.

La sofisticata bellezza di queste morbide superfici nasce dal voluto contrasto tra essenzialità del disegno e del dettaglio decorativo e la ricchezza della materia. Sottili righe alternate di lana e seta creano campiture geometriche in nuances di colori tono su tono che riflettono delicatamente la luce. Armonioso equilibrio tra rigore e forma.



CREAM GREY

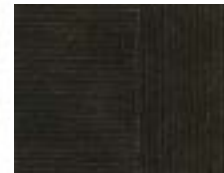

MILITARY GREEN



MINT GREEN

Dimensions / Dimensioni

500 x 400 cm

400 x 300 cm

300 x 300 cm

400 x 200 cm

Hand-tufted

Height fleece 14 mm

50% Wool, 50% Tencel

Taftato a mano

Spessore 14 mm

50% Lana, 50% Tencel



TELARO by Amini

MARTA FERRI

Telaro is a rug featuring a geometric motif and a linear pattern. A series of spaces arranged regularly with each other, featuring different sizes and orientations which thus define a contrasting grid. The precious semi-combed wool rug features a woven surface distinguished by a play of reliefs, achieved by means of skilled craftsmanship through hand loom.

Dal motivo geometrico e lineare nasce il tappeto Telaro. Un susseguirsi di spazi disposti regolarmente tra loro, caratterizzati da diverse grandezze e orientamenti che definiscono così una griglia a contrasto. Il tappeto, in preziosa lana semi pettinata, presenta una superficie intrecciata e contraddistinta da un gioco di rilievi, ottenuti da un'abile tecnica artigianale: la realizzazione tramite telaio manuale.



ANTHRACITE



COGNAC



NATURAL

Dimensions / Dimensioni

400 x 200 cm

Hand loomed

Intelaiato a mano

300 x 300 cm

Height fleece 6/7 mm

Spessore 6/7 mm

400 x 300 cm

Density 3,4 kg/mq

Peso 3,4 kg/mq

500 x 300 cm

Semi worsted wool

Lana semi pettinata

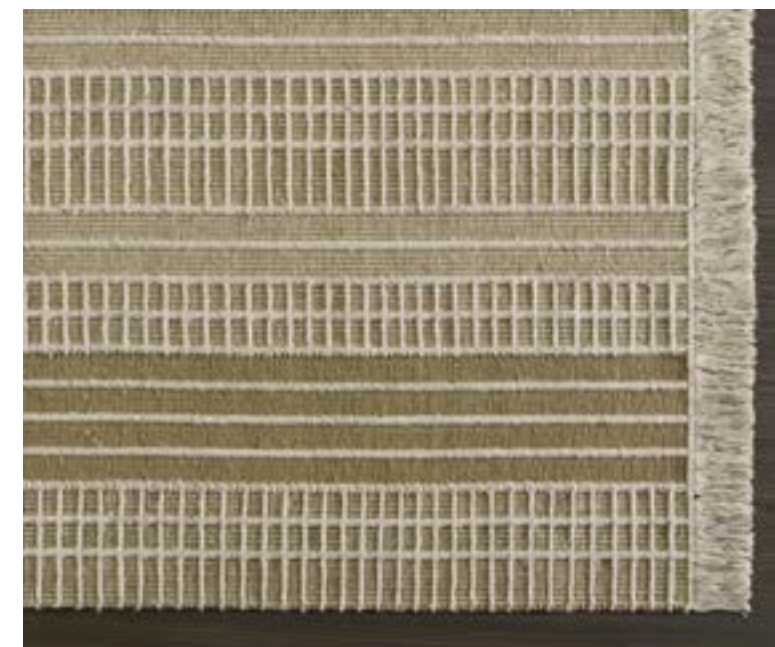

VIBRAZIONI Frammenti Collection

MARTA FERRI

Constantly changing scenarios give rise to Vibrazioni. A visual and tactile interplay, thanks to differing thicknesses and weaves on different levels that characterize the whole surface of the rug. Interplays of light and shade favoured by a glossy fibre such as rayon, skillfully combined dyes that vary according to the light.

Scenari in trasformazione in continuo cambiamento, dai quali nasce Vibrazioni. Un gioco optical visivo e tattile, grazie agli spessori e tra mature su diversi livelli che ne caratterizzano l'intera superficie del tappeto. Giochi di luci e ombre favoriti da una fibra lucente qual'è il rayon, poche tinte sapientemente ricercate che variano a seconda della luce.

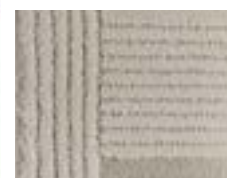

ICE



GRANITE



CLAY



GEM



EARTH



OBSIDIAN

Dimensions / Dimensioni

300 x 300 cm

400 x 200 cm

400 x 300 cm

500 x 400 cm

Hand-tufted

Height fleece 16/22 mm

100% Bamboo

Taftato a mano

Spessore 16/22 mm

100% Bamboo





Molteni&C

Finishes guideline

The "finishes guideline" document aims to guide the user through the available finishes for the main living and night systems and all the available finishes in real sample. We strongly suggest to build your projects looking to the dedicated price lists for living and night systems.

Il documento "finishes guideline" si propone come una guida esemplificativa delle finiture disponibili per i principali sistemi giorno e notte e per tutte le finiture prodotte in campione reale. Per tutti i dettagli in merito alla strutturazione del progetto, consigliamo la consultazione del corrispettivo listino giorno o notte.

SAMPLE AVAILABLE

Physical sample available and ready to order

CAMPIONE DISPONIBILE

Campione fisico disponibile e ordinabile







INDOOR FINISHES OVERVIEW*

OVERVIEW FINITURE INDOOR*



SAMPLE AVAILABLE

*NEW 2024

	MATT LACQUER	GLOSSY LACQUER	COLOURED GLASS	ETCHED COLOURED GLASS
	NO SAMPLES AVAILABLE			
WHITE LO01  ONLY Arial <input checked="" type="checkbox"/>	•	•		
CHALK WHITE BC <input checked="" type="checkbox"/>	•	•	•	•
ALMOND WHITE AW <input checked="" type="checkbox"/>	•	•	•	•
PEARL PE <input checked="" type="checkbox"/>	•	•	•	•
SILICA SI <input checked="" type="checkbox"/>	•	•	•	•
SAND SA <input checked="" type="checkbox"/>	•	•	•	•
DOVE GREY TO <input checked="" type="checkbox"/>	•	•	•	•
PLATINUM PL <input checked="" type="checkbox"/>	•	•	•	•
LONDON SKY LS <input checked="" type="checkbox"/>	•	•	•	•
DUNE DN <input checked="" type="checkbox"/>	•	•	•	•
IRIS IX  <input checked="" type="checkbox"/>	•	•	•	•
CAPPUCCINO CP  <input checked="" type="checkbox"/>	•	•	•	•
CLAY AL <input checked="" type="checkbox"/>	•	•	•	•
DOLOMITE GREY DO <input checked="" type="checkbox"/>	•	•	•	•
COPPER RX <input checked="" type="checkbox"/>	•	•	•	•
RUBY RU <input checked="" type="checkbox"/>	•	•	•	•
BURGUNDY BG <input checked="" type="checkbox"/>	•	•	•	•

 The document aims to show all the finishes produced, highlighting if the real sample is available or not. For every detail and usage of each finish you must look at the dedicated price list. Colors are to be considered as purely indicative.
 Il documento è una guida a tutte le finiture prodotte con indicazione della presenza o meno del campione reale. Per ogni dettaglio relativo all'applicazione delle finiture su vari prodotti, bisogna fare riferimento esclusivamente ai listini. I colori sono puramente indicativi.

* kitchen and outdoor collections excluded
 * collezioni cucine e outdoor escluse

	MATT LACQUER	GLOSSY LACQUER	COLOURED GLASS	ETCHED COLOURED GLASS
	NO SAMPLES AVAILABLE			
MOKA MK <input checked="" type="checkbox"/>	•	•	•	•
MUSTARD SE <input checked="" type="checkbox"/>	•	•	•	•
SPICE SP <input checked="" type="checkbox"/>	•	•	•	•
LIGHT GREY LO06  ONLY Arial <input checked="" type="checkbox"/>	•	•		
STARDUST SU <input checked="" type="checkbox"/>	•	•	•	•
MOONLIGHT ML <input checked="" type="checkbox"/>	•	•	•	•
LIGHT BLUE GREY CZ <input checked="" type="checkbox"/>	•	•	•	•
PETROLEUM BLUE PR <input checked="" type="checkbox"/>	•	•	•	•
PEWTER PX <input checked="" type="checkbox"/>	•	•	•	•
LEAD LO63  ONLY Arial <input checked="" type="checkbox"/>	•	•		
ANTHRACITE AT <input checked="" type="checkbox"/>	•	•	•	•
PINE GREEN PG <input checked="" type="checkbox"/>	•	•	•	•
BLACK NE <input checked="" type="checkbox"/>	•	•	•	•
SPECIAL LACQUER				
GLAZE GBX ONLY 505, Gliss Master <input checked="" type="checkbox"/>				
ECLIPSE LEC ONLY Blevio <input checked="" type="checkbox"/>				
GALAXY GY ONLY Cleo				
SLATE LA ONLY Hector <input checked="" type="checkbox"/>				
3D ALL THE COLOURS OF MOLteni THE RANGE <input checked="" type="checkbox"/> Sample ONLY 3D Copper				

Overlay etched or transparent glass sample onto any lacquer sample to get the effect of the corresponding coloured etched or coloured glass.
 Sovrapporre un campione di vetro trasparente o acidato su qualsiasi campione laccato per ottenere l'effetto del corrispondente vetro colorato acidato o vetro colorato.

















INDOOR FINISHES OVERVIEW*

OVERVIEW FINITURE INDOOR*











SAMPLE AVAILABLE

*NEW 2024

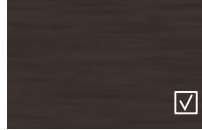
WOODS

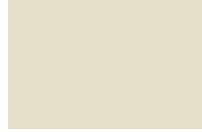
Ash Wood In Natural Colour FNA		Sunrise oak rays RRS	
Sunrise oak RS		Eucalyptus rays REU	
American Walnut CN		Graphite oak rays RRF	
Walnut NO		Thermo oak rays RRT	
Thermo oak RT		Coffee oak rays RRC	
Eucalyptus EU			
Black Oak RN			
Ash wood stained black FTN			
Coffee oak RC			
Graphite oak RF			

METAL PARTS

Black Nickel NN	
Shiny aluminium AU	
Pewter colour PT	
Bronze BZ	
Green VD	
Copper RM	
Iris IR	
Sand metal Only Paula SB	
Polished Brass Only Aster OT	
Patinated black brass Only Aster OP	
Shiny steel Only Mateo basement AK	









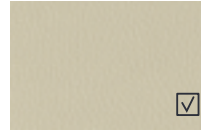
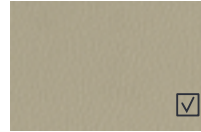

The document aims to show all the finishes produced, highlighting if the real sample is available or not. For every detail and usage of each finish you must look at the dedicated price list. Colors are to be considered as purely indicative.



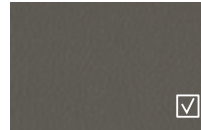



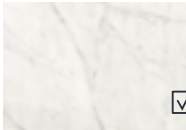

Il documento è una guida a tutte le finiture prodotte con indicazione della presenza o meno del campione reale. Per ogni dettaglio relativo all'applicazione delle finiture su vari prodotti, bisogna fare riferimento esclusivamente ai listini. I colori sono puramente indicativi.

* kitchen and outdoor collections excluded
* collezioni cucine e outdoor escluse

ECO SKIN

Ivory ESAV	
Hemp ESCA	
Mink ESVI	
Earth ESTE	
Artic ESAC	
Taupe ESTA	
Grey ESGR	
Dark brown ESTM	
LAVA STONE	
Matt finish Only Regent	
Glossy polyester finish Only Regent	

MARBLES

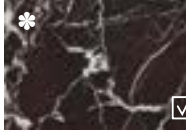
White Carrara MBC	
Calacatta MCA	
Orient Grey MGO	
Emperador Dark MED	
Black Marquina MNM	
Sahara Noir MSN	
Silver Wave MSW	
Green Alpine MVA	
Breccia Capraia MBR	
Lepanto red MLR	

CERAMIC

Calacatta Vena Vecchia
HCA
Only Harry's Bar 505 Up System back panels



CEMENT LOUISA

Brick red
CMT



Ash
CGC



White
CBN



CEMENT ARC

Black
CNE



Bronze
CBR



Grey
CGR



White
CBI



Brick red
CMT















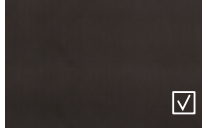

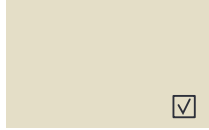
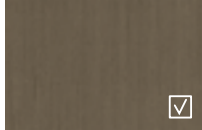

INDOOR FINISHES OVERVIEW*

OVERVIEW FINITURE INDOOR*

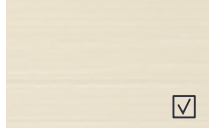
SAMPLE AVAILABLE

*NEW 2024

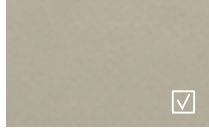
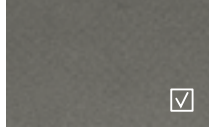
MELAMINE

Silver cembran YA		Silk Chalk White ZB		Fine grain FG1	
Larix dark YM		Silk Silica ZS		Piqué XQ	
Light Chestnut QC		Silk Dove Grey ZT		Lunar JLU	
Dark Chestnut QS		Cartapaglia white KB			
Grey Tatami QG		Cartapaglia silica KS			
Ivory Tatami QA		Cartapaglia anthracite KA			
Wax white WW		Batik Ecrú XE			
		Batik Slate XA			
		Grey Saffiano			
		Ecrú Saffiano			











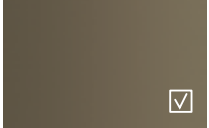

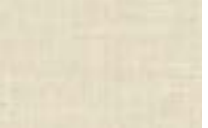







The document aims to show all the finishes produced, highlighting if the real sample is available or not. For every detail and usage of each finish you must look at the dedicated price list. Colors are to be considered as purely indicative.

Il documento è una guida a tutte le finiture prodotte con indicazione della presenza o meno del campione reale. Per ogni dettaglio relativo all'applicazione delle finiture su vari prodotti, bisogna fare riferimento esclusivamente ai listini. I colori sono puramente indicativi.

* kitchen and outdoor collections excluded
* collezioni cucine e outdoor escluse

GLASSES

Bronze mirror SPB		Textured green Only Aster VRVE		Vanilla TEVA	
Transparent VTR		Textured smoked Only Aster VRFU		Oxide Orange TEOO	
Fumé / Smoked VTFU		Transparent stopsol VTSR		Bark Brown TEBB	
Etched glass VA		Stopsol etched VTST		Olive Green TEOG	
3D etched bronze V3BZ		Stopsol Net VTSN		Moss Green TEMG	
Graphene reflective Only Half A Square/ Diamond VTRR		Stopsol Bronze VTSB			
Bronze VBO		Stopsol Silver VTSS			





TECHNICAL DRAWINGS
DISEGNI TECNICI

ALDGATE RODOLFO DORDONI

BED
LETTO

OUTER DIMENSIONS 70³/₄"-74³/₄"-78³/₄"-86³/₄"x93³/₄"
H 38¹/₄" / QS68⁷/₈"xQS95³/₈" / KS84¹/₂"xKS95¹/₈" H 38¹/₄"
DIMENSIONI ESTERNE 180-190-200-220x238
H 97 / QS175xQS243 / KS215xKS243 H 97

BENCH
PANCA

BENCH DIMENSIONS 64¹/₈"x20⁷/₈" H 14¹/₈"
DIMENSIONI PANCA 163X53 H 36

ANTON VINCENT VAN DUYSSEN

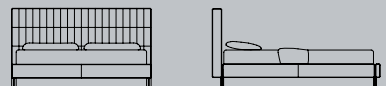
BED
LETTO

OUTER DIMENSIONS 68³/₄"-72³/₈"-76³/₈"-84¹/₂"x87³/₈"
H 41³/₈" / QS66⁷/₈"xQS89³/₈" / KS82¹/₂"xKS89¹/₈" H 41³/₈"
DIMENSIONI ESTERNE 174,5-184,5-194,5-214,5x222
H 105 / QS169,5xQS227 / KS209,5xKS227 H 105

BENCH
PANCA

BENCH DIMENSIONS 55¹/₈"x15³/₄" H 16¹/₂"
DIMENSIONI PANCA 140X40 H 42

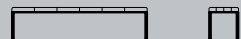
BENCH
PANCA

BENCH DIMENSIONS 70³/₈"x15³/₄" H 16¹/₂"
DIMENSIONI PANCA 180X40 H 42

AZUL NICOLA GALLIZIA

BED
LETTO

OUTER DIMENSIONS 69³/₈"-73³/₈"-77¹/₂"x87"
H 39³/₄"-42¹/₈"-42³/₈" / QS66⁷/₈"x88³/₈" / KS82³/₄"xKS88³/₈"
H 39³/₄"-42¹/₈"-42³/₈"
DIMENSIONI ESTERNE 177-187-197x221
H 101-107-107,5 / QS170x225 / KS210xKS225 H 101-107-107,5

BENCH
PANCA

BENCH DIMENSIONS 65³/₈"x16¹/₈" H 16⁷/₈"
DIMENSIONI PANCA 166X41 H 43

FULHAM RODOLFO DORDONI

BED - LOWER BEDFRAME
LETTO - FASCIA BASSA

OUTER DIMENSIONS 68⁷/₈"-72⁷/₈"-76³/₄"-84³/₈"x88³/₈" H 41" / KS82³/₄"xKS90¹/₂" H 41"
DIMENSIONI ESTERNE 175-185-195-215x225 H 104 / KS210xKS230 H 104

BED - HIGHER BEDFRAME
LETTO - FASCIA ALTABENCH
PANCA

BENCH DIMENSIONS 55¹/₈"x17³/₄" H 16¹/₂"
DIMENSIONI PANCA 140X45 H 42

HIGH-WAVE HANNES WETTSTEIN

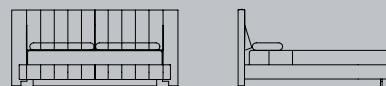
BED
LETTO

OUTER DIMENSIONS 78³/₄"-82³/₄"-86³/₈"x86³/₈" H 41" / KS92¹/₂"xKS88³/₈" H 41"
DIMENSIONI ESTERNE 200-210-220x220 H 104 / KS235xKS225 H 104

HONEY ARIK LEVY

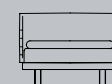
SINGLE BED
LETTO SINGOLODOUBLE BED
LETTO MATRIMONIALE

OUTER DIMENSIONS 41³/₄"-49³/₈"-65³/₈"-69¹/₄"-73¹/₄"x86³/₈" H 37³/₄" / QS62³/₈"xQS88³/₈" / KS78³/₈"xKS88³/₈" H 37³/₄"
DIMENSIONI ESTERNE 106-126-166-176-186x220 H 96 / QS159xQS225 / KS199xKS225 H 96

OVIDIO VINCENT VAN DUYSSEN

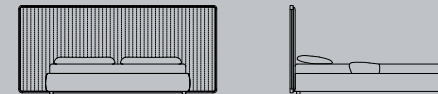
BED
LETTO

OUTER DIMENSIONS 95¹/₄"-103¹/₈"x84¹/₄" H 46¹/₄" / KS103¹/₈"xKS85⁷/₈" H 46¹/₄"
DIMENSIONI ESTERNE 242-262x214 H 117,5 / KS262xKS218 H 117,5

RIBBON VINCENT VAN DUYSSEN

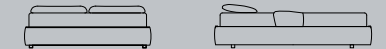
SINGLE BED
LETTO SINGOLODOUBLE BED
LETTO MATRIMONIALESINGLE BEDFRAME
SOMMIER SINGOLODOUBLE BEDFRAME
SOMMIER MATRIMONIALE

OUTER DIMENSIONS 43¹/₄"-66⁷/₈"-70⁷/₈"-74³/₄"-82³/₄"x83¹/₈" H 43¹/₄" / QS65"xQS85" / KS80³/₄"xKS85" H 43¹/₄"
DIMENSIONI ESTERNE 110-170-180-190-210x211 H 110 / QS165xQS216 / KS205XKS216 H 110

WISH RODOLFO DORDONI

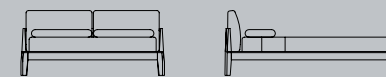
BED
LETTO

OUTER DIMENSIONS 70⁷/₈"-74³/₄"-78³/₄"x91" H 33⁷/₈"
DIMENSIONI ESTERNE 180-190-200x231 H 86



45°/TAVOLINO RON GILAD

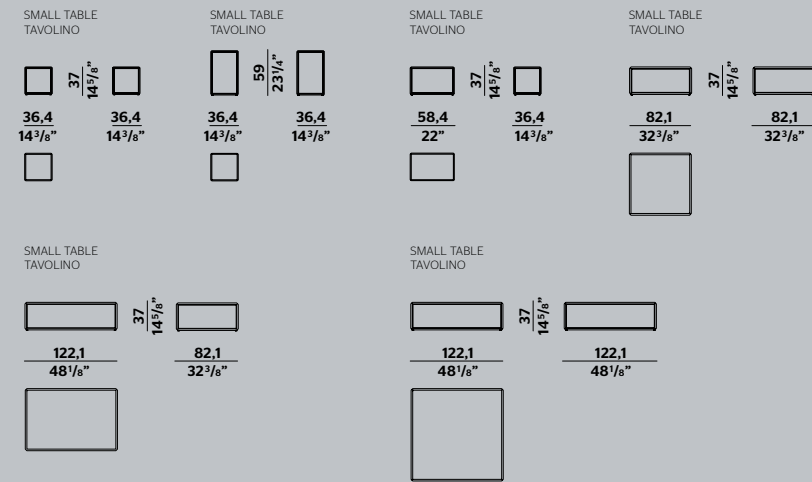

ASTER VINCENT VAN DUYSSEN

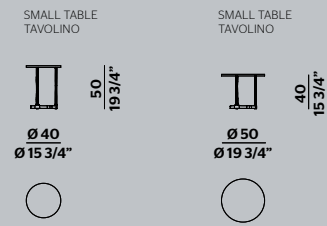

ATTICO NICOLA GALLIZIA

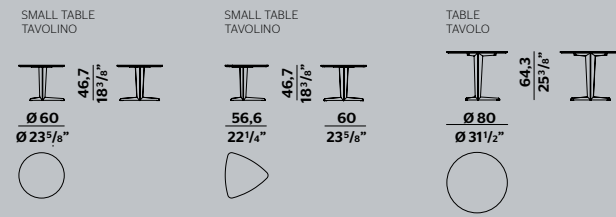

D.552.2 GIO PONTI

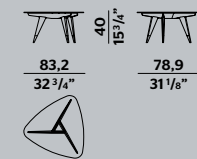

D.555.1 GIO PONTI

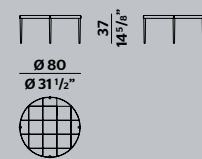

DOMINO NEXT NICOLA GALLIZIA

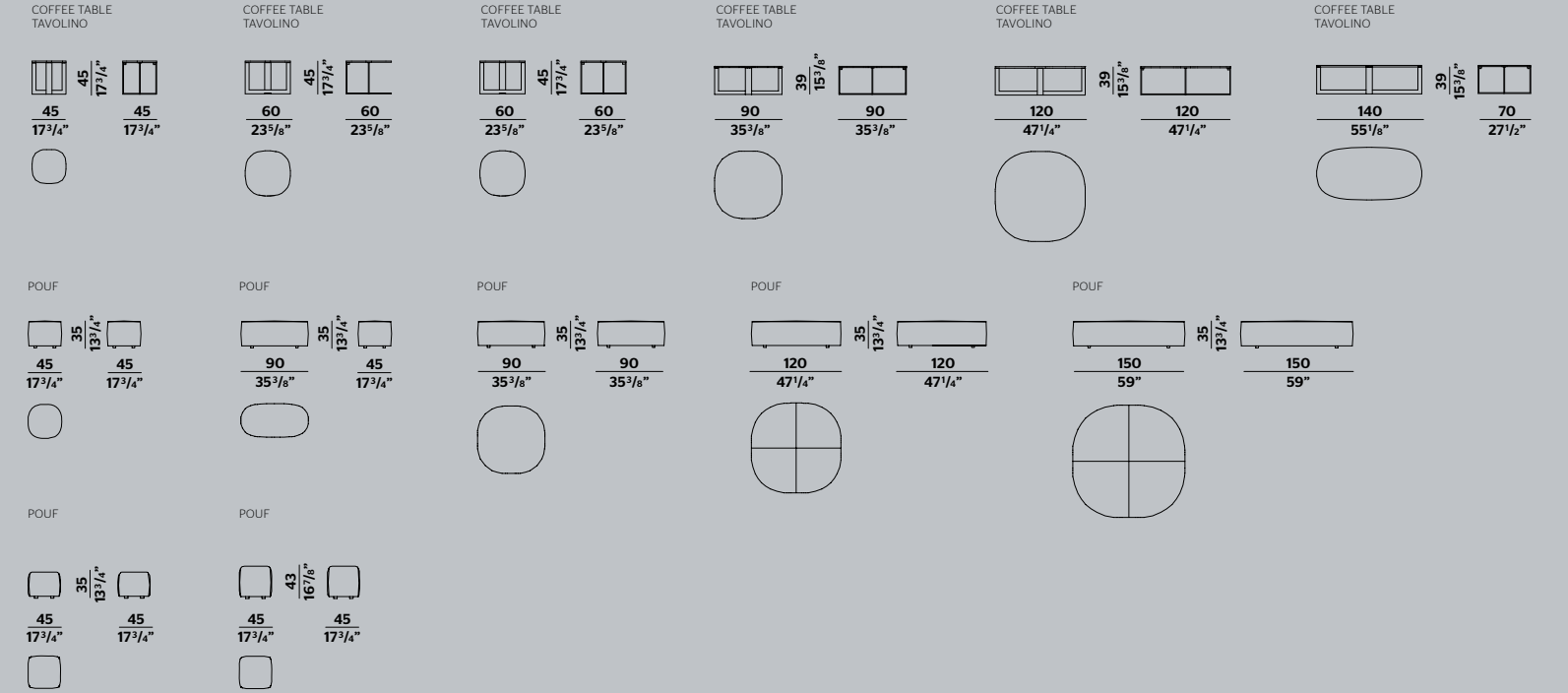

FONTE VINCENT VAN DUYSSEN

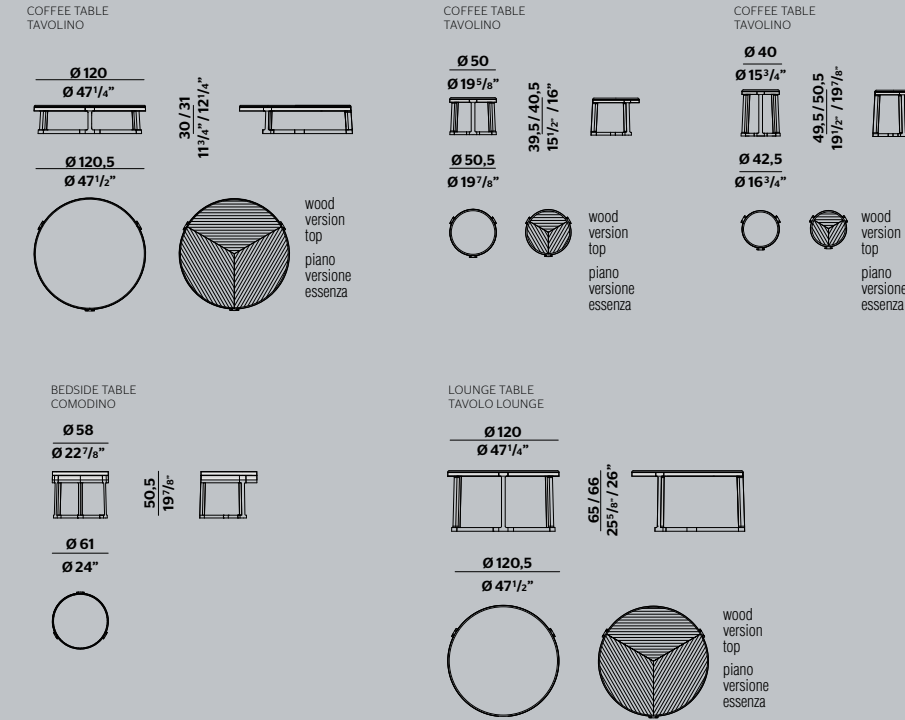

LOUISA VINCENT VAN DUYSSEN

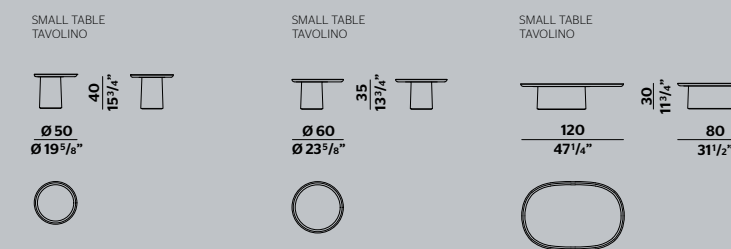

PANNA COTTA RON GILAD

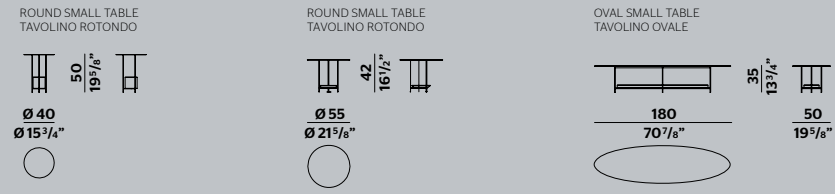

REGENT VINCENT VAN DUYSSEN

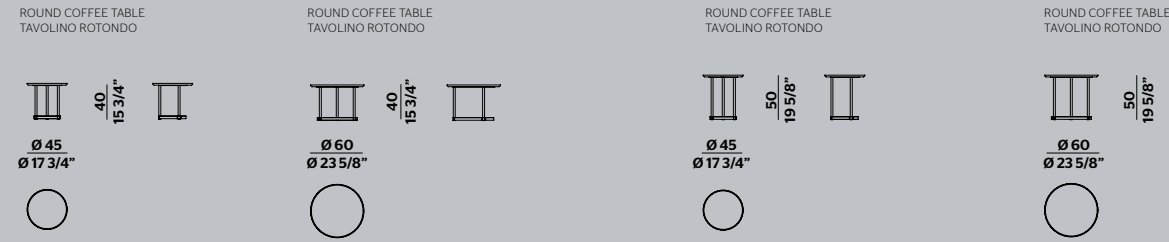
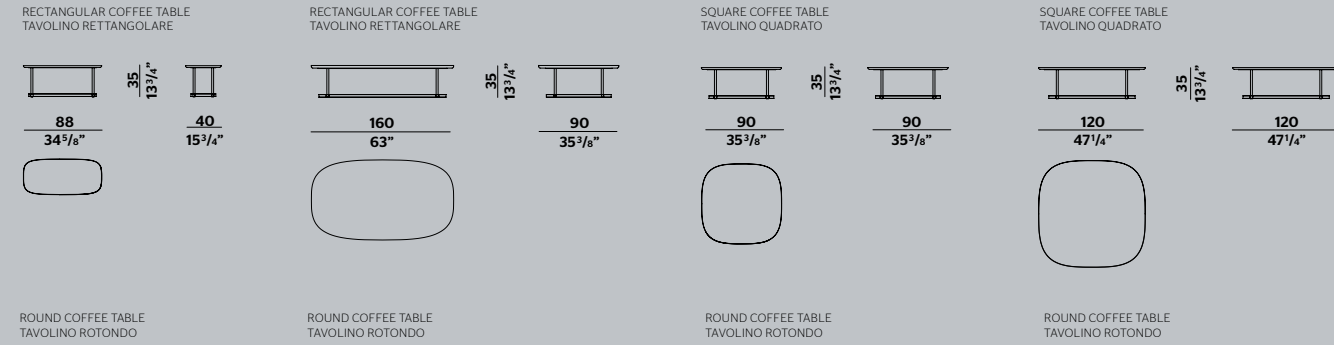

VICINO TABLE FOSTER + PARTNERS

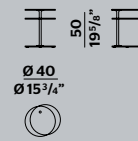

WHEN RODOLFO DORDONI

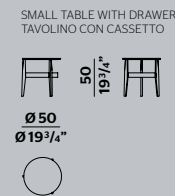

BALTIMORA MATTEO NUNZIATI

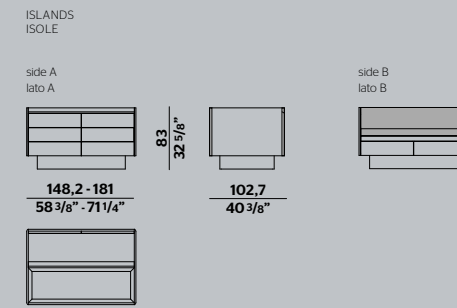

CASPER VINCENT VAN DUYSSEN

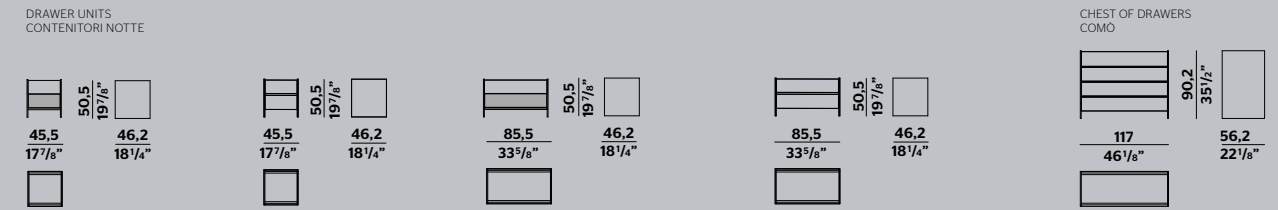

606 RODOLFO DORDONI

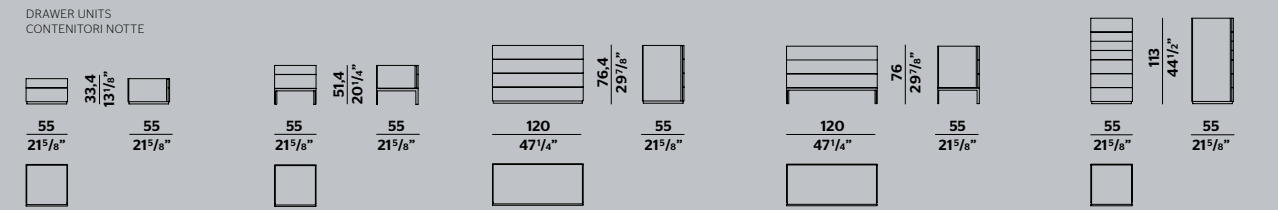

7070 RODOLFO DORDONI

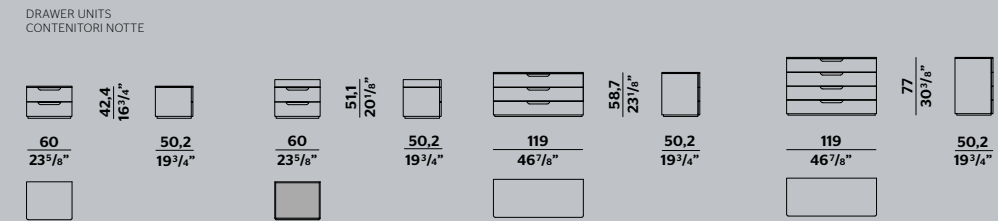

909 LUCA MEDA

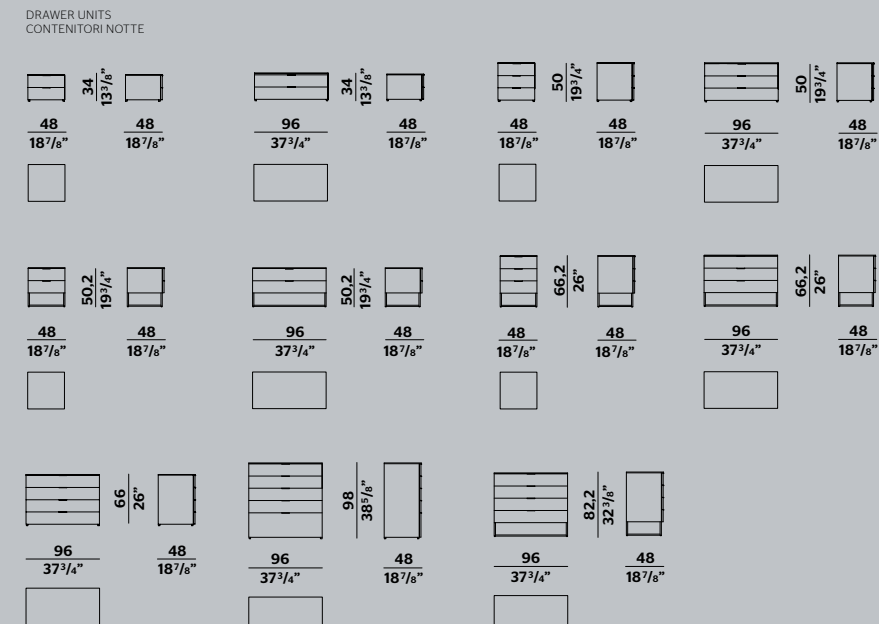

4040 DANTE BONUCCELLI

DRAWER UNITS
CONTENITORI NOTTE

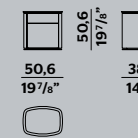

5050 RODOLFO DORDONI

DRAWER UNITS
CONTENITORI NOTTE

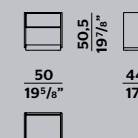

RIGHT VERSION-DX
VERSIONE DX

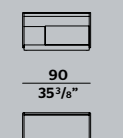

LEFT VERSION-SX
VERSIONE SX

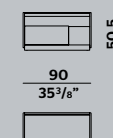

CHEST OF DRAWERS
COMO

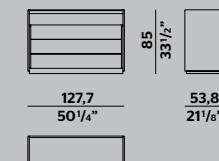

D.655.1 D.655.2 GIO PONTI

DRAWER UNITS
CONTENITORI NOTTE

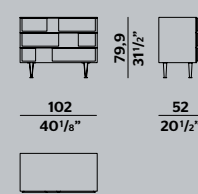
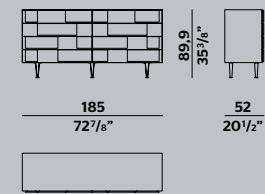

MHC.1 WERNER BLASER

DRAWER UNIT
CASSETTIERA

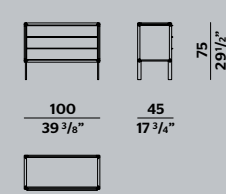

TEOREMA RON GILAD

UNITS WITH DRAWERS OR OPEN COMPARTMENT
CONTENITORI A CASSETTO O A GIORNO

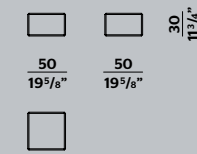
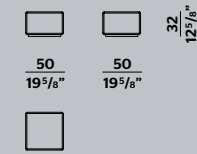
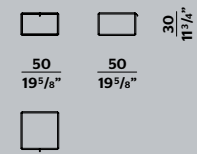
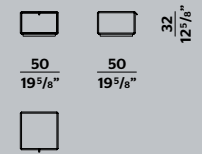
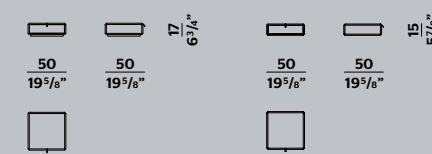

VERTICAL COMPOSITIONS H 18 1/2"
COMPOSIZIONI VERTICALI H 47



VERTICAL COMPOSITIONS H 24 3/8"
COMPOSIZIONI VERTICALI H 62

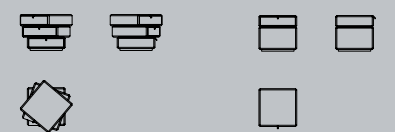

VERTICAL COMPOSITIONS H 30 3/8"
COMPOSIZIONI VERTICALI H 77

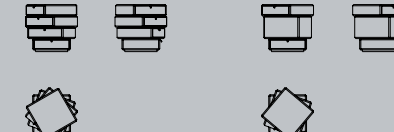

VERTICAL COMPOSITIONS H 36 1/8"
COMPOSIZIONI VERTICALI H 92

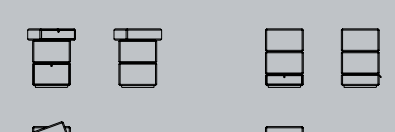

VERTICAL COMPOSITIONS H 42 1/8"
COMPOSIZIONI VERTICALI H 107

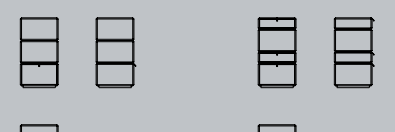

VERTICAL COMPOSITIONS H 48"
COMPOSIZIONI VERTICALI H 122

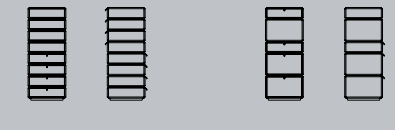

HORIZONTAL COMPOSITIONS H 12 5/8"
COMPOSIZIONE ORIZZONTALE H 32

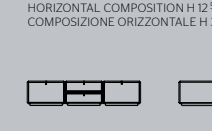

HORIZONTAL COMPOSITIONS H 24 3/8"
COMPOSIZIONI ORIZZONTALI H 62

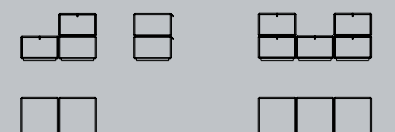

505 UP SIDEBBOARD NICOLA GALLIZIA

FINISHED COMPOSITIONS
COMPOSIZIONI FINITE

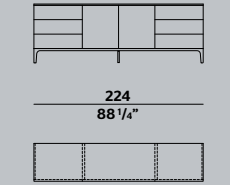
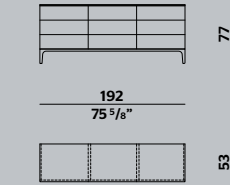
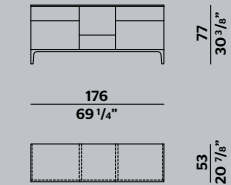
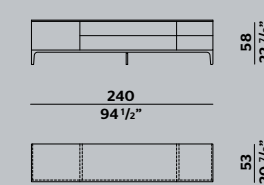

FINISHED COMPOSITIONS
COMPOSIZIONI FINITE

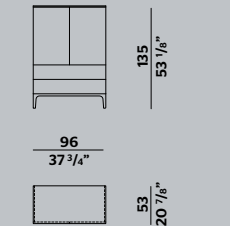
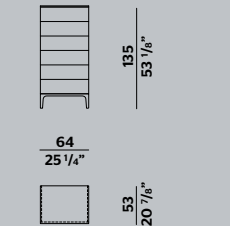
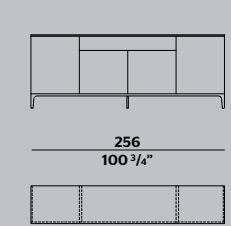
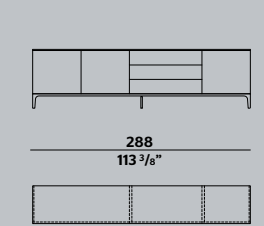

FINISHED COMPOSITIONS
COMPOSIZIONI FINITE

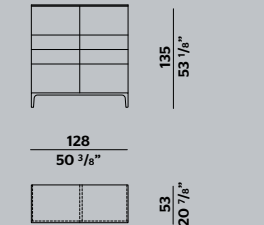

FLOOR STANDING STORAGE UNIT WITH PLINTH
AND WITH OPEN COMPARTMENTS
CONTENITORE A TERRA CON ZOCCOLO
E CON VANI A GIORNO

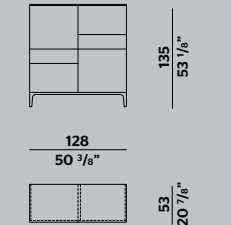

PASS-WORD EVOLUTION DANTE BONUCCELLI

FLOOR STANDING BASE WITH METAL BASE
AND WITH OPEN COMPARTMENT
BASE A TERRA CON BASAMENTO
E CON VANO A GIORNO

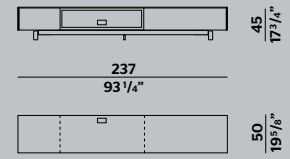

FLOOR STANDING STORAGE UNIT WITH METAL BASE
CONTENITORE A TERRA CON BASAMENTO

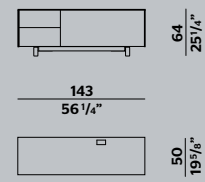

FLOOR STANDING STORAGE UNIT WITH METAL BASE
CONTENITORE A TERRA CON BASAMENTO

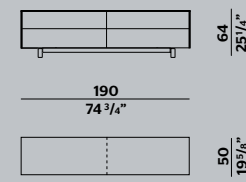

FLOOR STANDING STORAGE UNIT WITH METAL BASE
AND WITH OPEN COMPARTMENT
CONTENITORE A TERRA CON BASAMENTO
E CON VANO A GIORNO

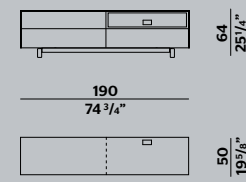

FLOOR STANDING STORAGE UNIT WITH PLINTH
AND WITH OPEN COMPARTMENT
CONTENITORE A TERRA CON ZOCCOLO
E CON VANO A GIORNO

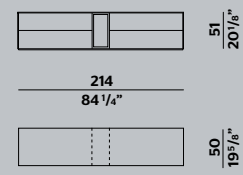

FLOOR STANDING STORAGE UNIT WITH PLINTH
AND WITH OPEN COMPARTMENTS
CONTENITORE A TERRA CON ZOCCOLO
E CON VANI A GIORNO

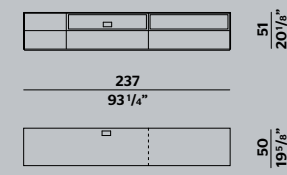

FLOOR STANDING SIDEBOARD WITH PLINTH
MADIA A TERRA CON ZOCCOLO

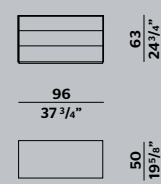

FLOOR STANDING SIDEBOARD WITH METAL BASE
MADIA A TERRA CON BASAMENTO

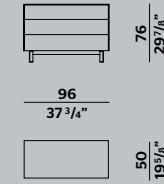

FLOOR STANDING SIDEBOARD WITH PLINTH
MADIA A TERRA CON ZOCCOLO

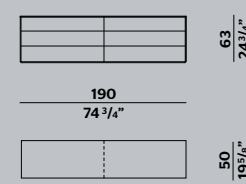

FLOOR STANDING SIDEBOARD WITH METAL BASE
MADIA A TERRA CON BASAMENTO

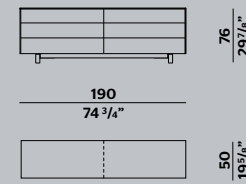

NOTE MATTEO NUNZIATI

WRITING DESK
SCRITTOIO

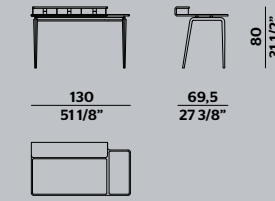

SCRIBA PATRICIA URQUIOLA

WRITING DESK
SCRITTOIO

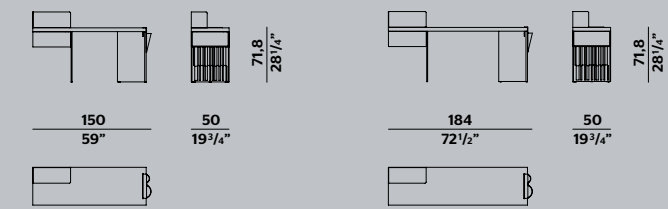

D.847.1 GIO PONTI

WRITING DESK
SCRITTOIO

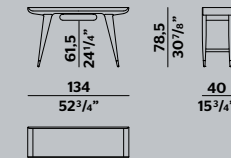

D.950.1 GIO PONTI

FRAMED MIRRORS
CORNICI CON SPECCHIO



HECTOR MIRROR VINCENT VAN DUYSSEN

MIRRORS
SPECCHIERE

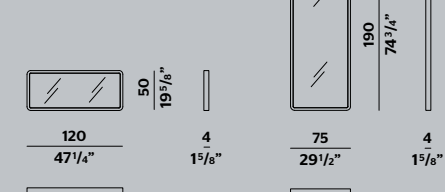

D.754.1 GIO PONTI

CARPET
TAPPETO

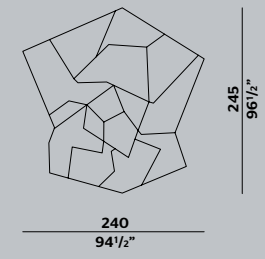

ATALANTE by Ruckstuhl NICOLA GALLIZIA

CARPETS
TAPPETI

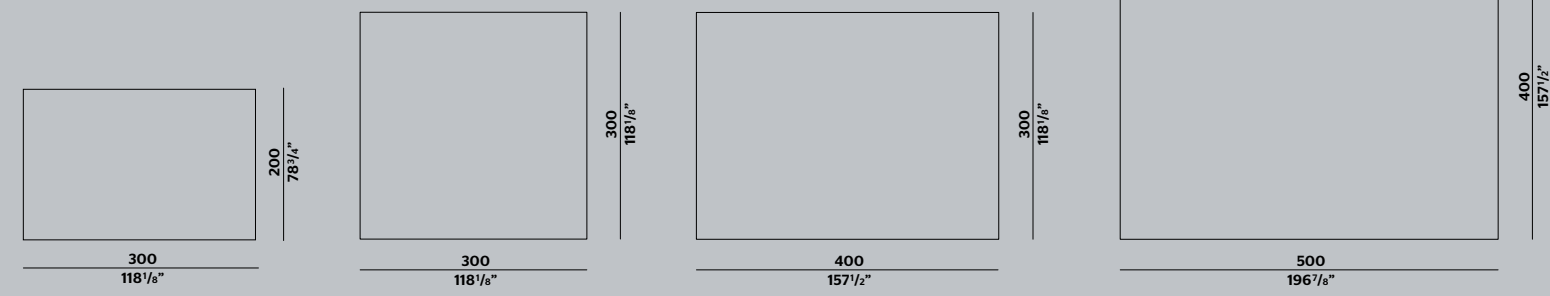

DEDALO by Pierre Frey MARTA FERRI

CARPETS
TAPPETI

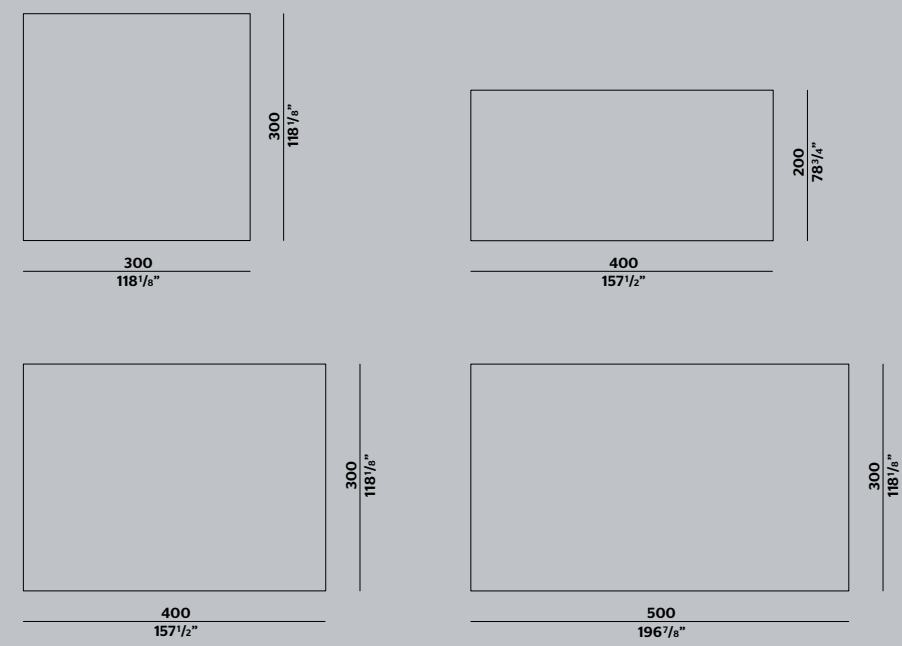

DUNA NICOLA GALLIZIA

CARPETS
TAPPETI

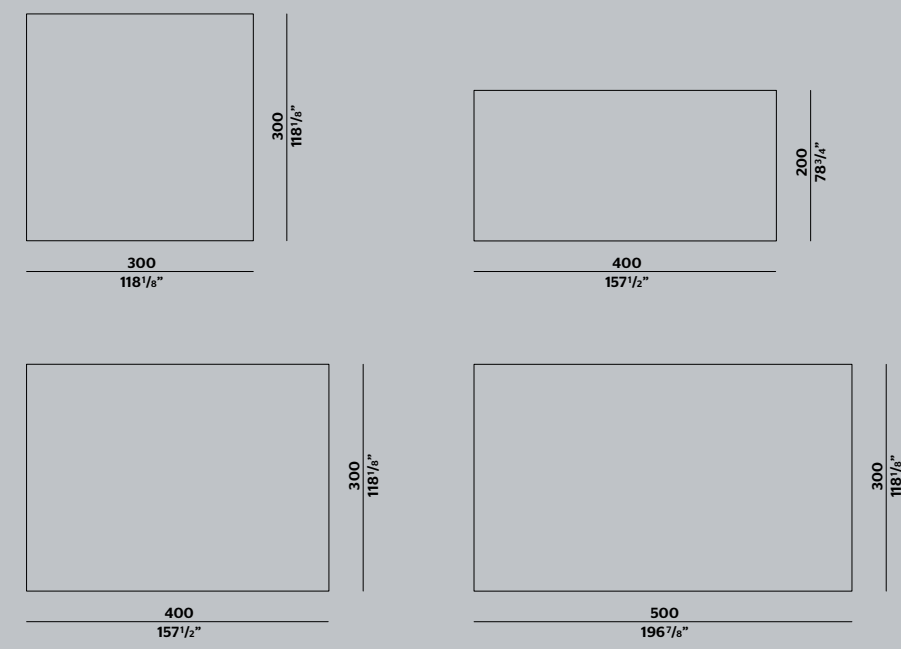

EDGE NICOLA GALLIZIA

CARPETS
TAPPETI

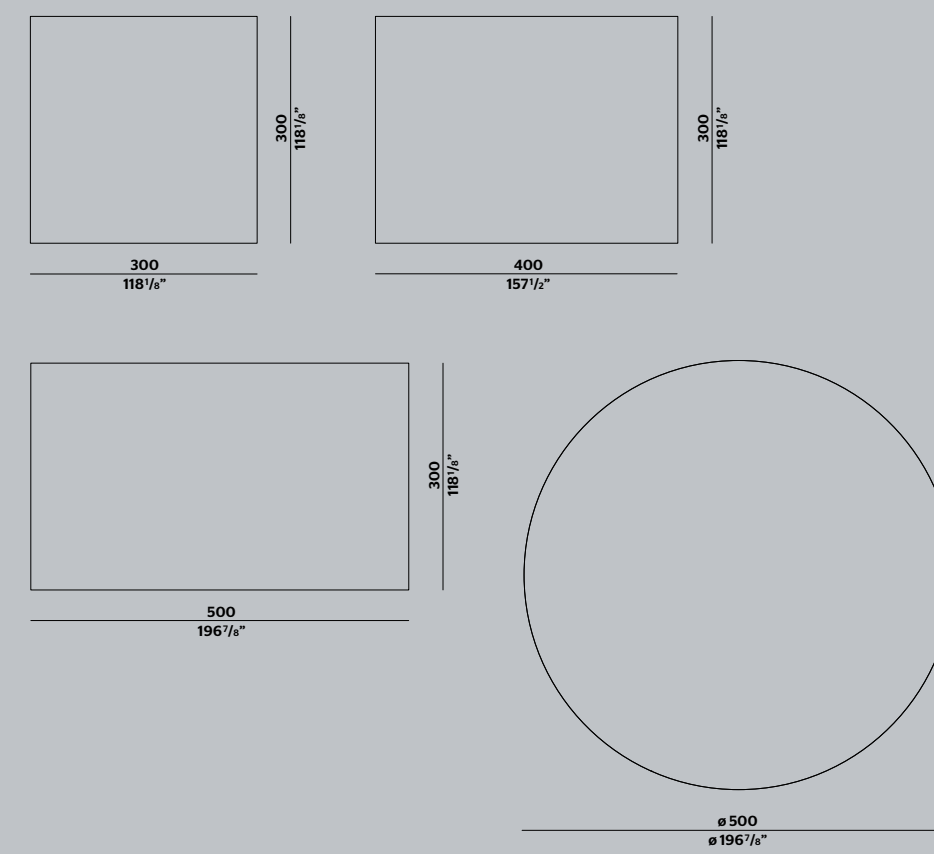

HEM by G.T.Design PATRICIA URQUIOLA

CARPETS
TAPPETI

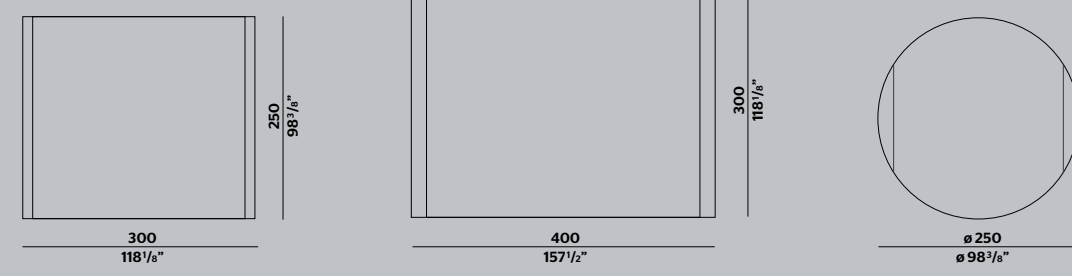

PALETTE NICOLA GALLIZIA

CARPETS
TAPPETI

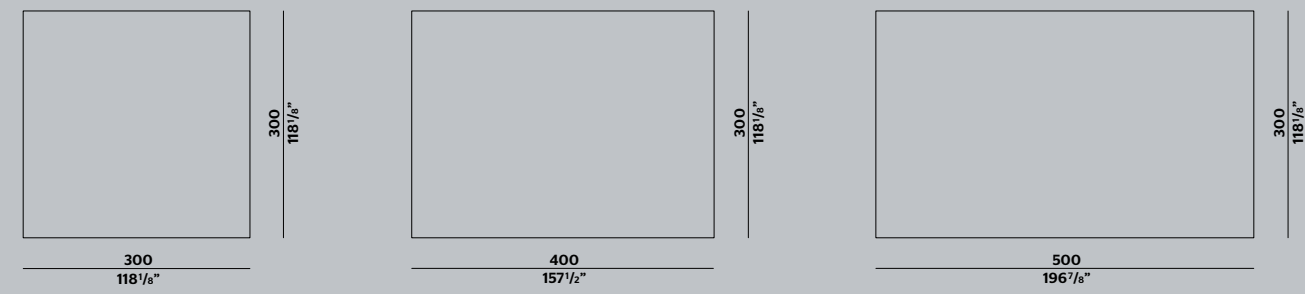

RANDOM by Altai PATRICIA URQUIOLA

CARPETS
TAPPETI

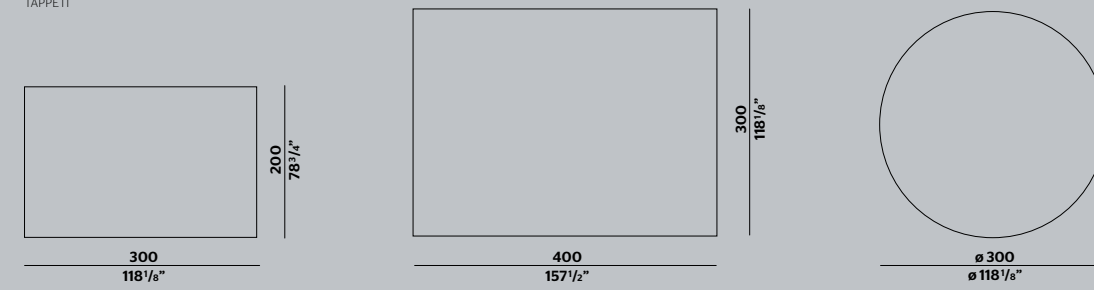

STRIPE VINCENT VAN DUYSSEN

CARPETS
TAPPETI

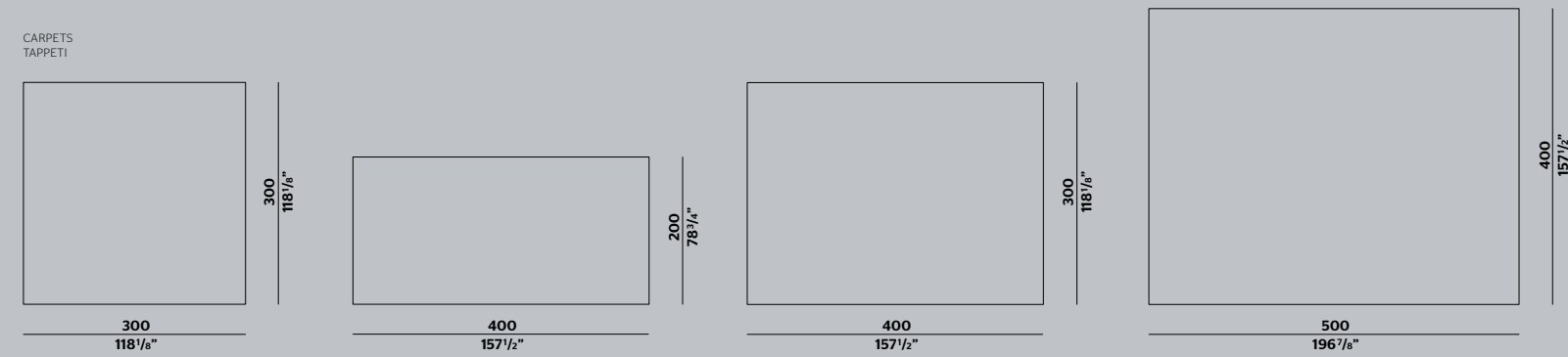

TELARO by Amini MARTA FERRI

CARPETS
TAPPETI

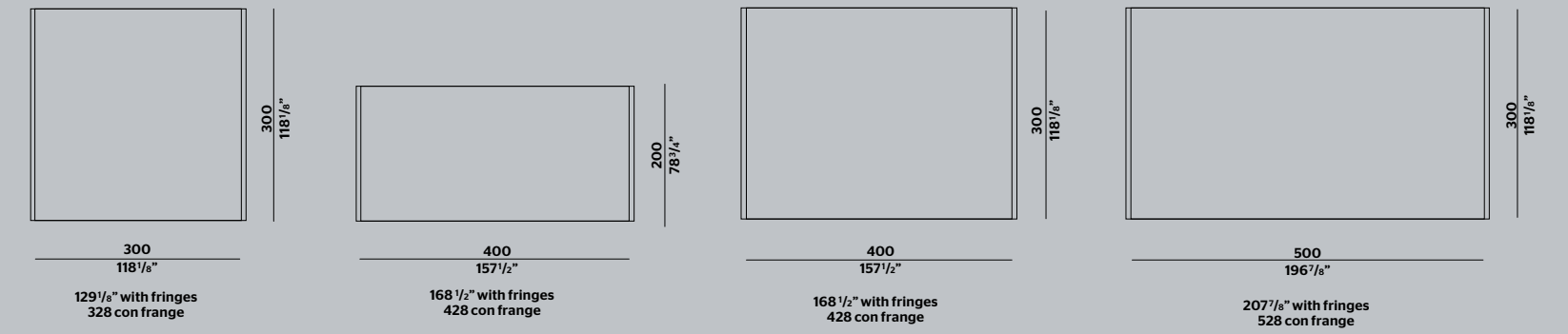

AURA NICOLA GALLIZIA

CARPETS
TAPPETI

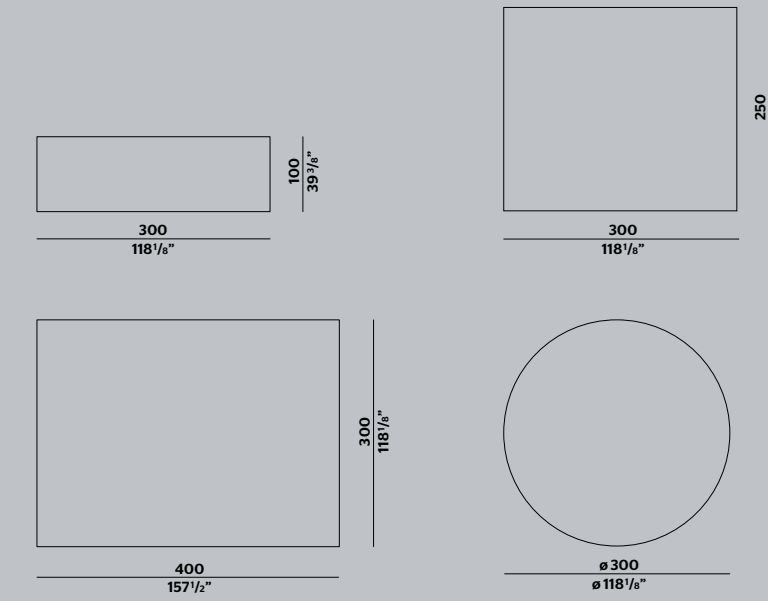

VIBRAZIONI MARTA FERRI

CARPETS
TAPPETI

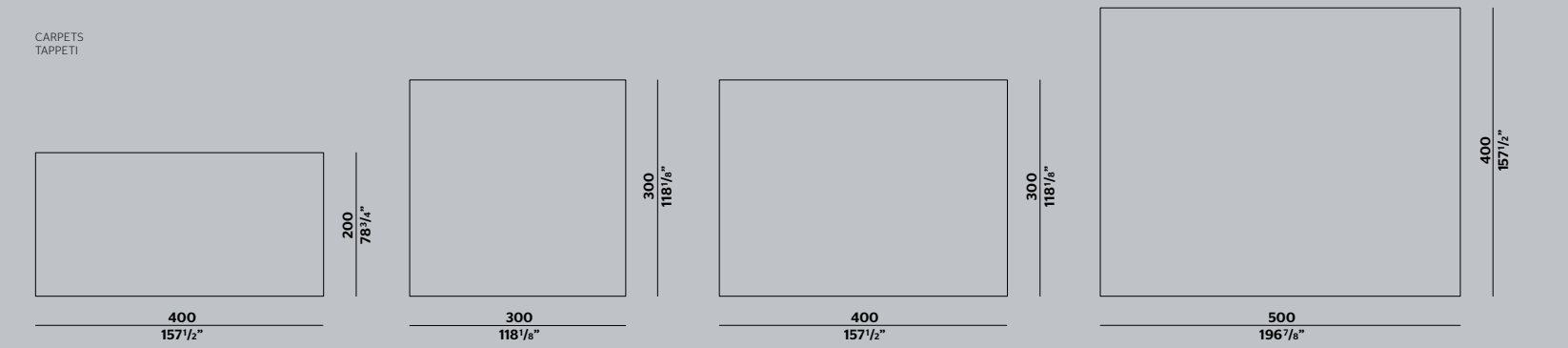

EONE NICOLA GALLIZIA

CARPETS
TAPPETI

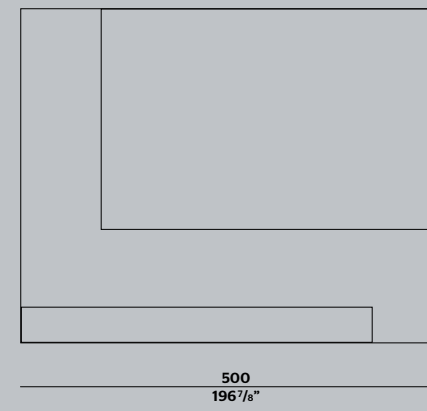
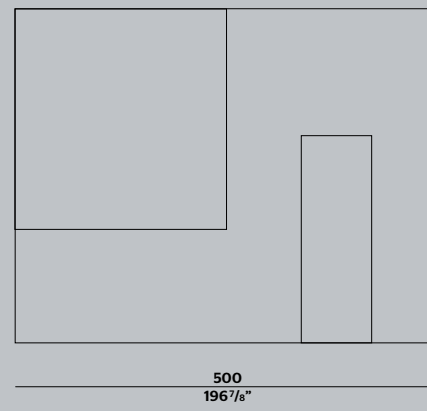
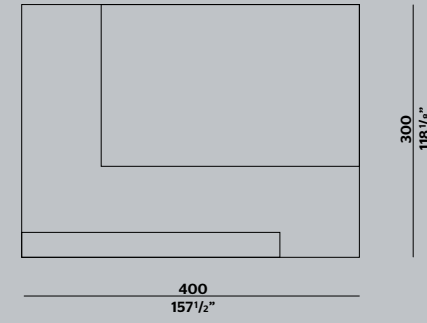
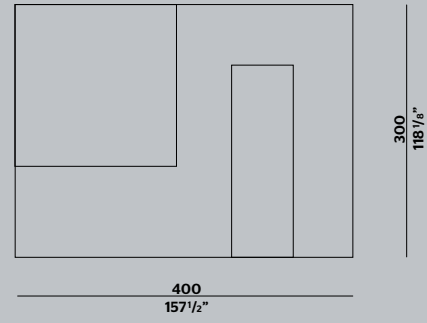
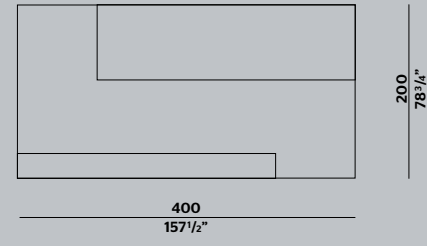
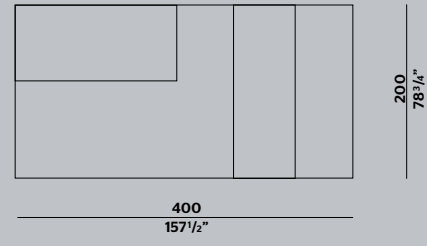

SONORO NICOLA GALLIZIA

CARPETS
TAPPETI

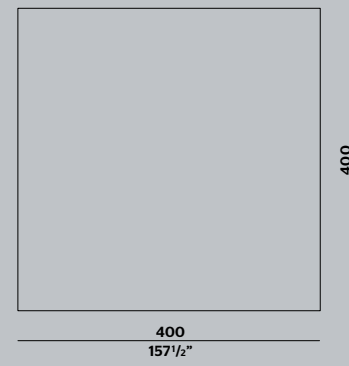
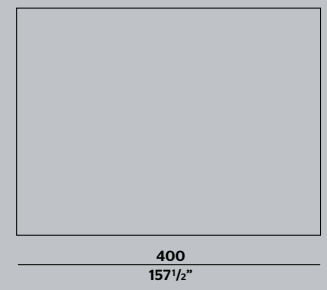
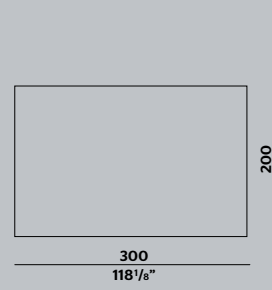

PHOTO 2022/24 THANKS TO

ALFREDO RAPETTI MOGOL
KALPA ART LIVING GALLERIES
MARCO SOLZI PAINTINGS
YASMIN BRANDOLINI D'ADDA

PLH
MOTTURA

1+1 GALLERY
ARTEK
ARTEMIDE
ASTEP
CTO LIGHTING
ENRICO DONADELLO
FEDERICA BUBANI
KLASSIK STUDIO
KRISTINA DAM
NEMO LIGHTING
SEASE
STILNOVO
VENICEM

AD

VINCENT VAN DUYSEN

STYLING

ALESSANDRO PASINELLI STUDIO

PHOTO

MAX ZAMBELLI
TIZIANO SARTORIO
MAX ROMMEL
ARMANDO BERTACCHI
VITTORIO DOZIO
ANDREA ANSALONE



PREMI COMPASSO D'ORO ADI

COMPASSO D'ORO ADI XVII EDIZIONE,
1994 PREMIO ALLA CARRIERA
2024 CAREER AWARD FOR PRODUCTS D.154.2
DESIGN BY GIO PONTI

MENZIONI D'ONORE

COMPASSO D'ORO ADI

COMPASSO D'ORO ADI XIV, EDIZIONE
1987, LES BEAUX JOURS (LUCA MEDA)
COMPASSO D'ORO ADI XXII, EDIZIONE
2011, SEQUENCE (PATRICIA URQUIOLA)
COMPASSO D'ORO ADI, EDIZIONE XXIII, 2014,
QALLAM, (F. MOLTENI; C. COLLI; P. HEFTI)
2020 ADI COMPASSO D'ORO

PREMI ADI INNOVAZIONE

PREMIO NAZIONALE INNOVAZIONE
ADI, 2012, QALLAM
PREMIO DEI PREMI,
PRESIDENZA REPUBBLICA ITALIANA,
EDIZIONE 2012 QALLAM



MADE
IN
ITALY



moltenigroup.com
moltenimuseum.com
#MolteniGroup
#MolteniMuseum

ONLINE STORE for US market

Molteni&C selected pieces
available also at shop.molteni.it



@MolteniandC



@MolteniandC



Molteni&C



@MolteniandC



MolteniandC



Molteni&C



MolteniC



MolteniandC

■▼■ **MOLTENIGROUP.COM**



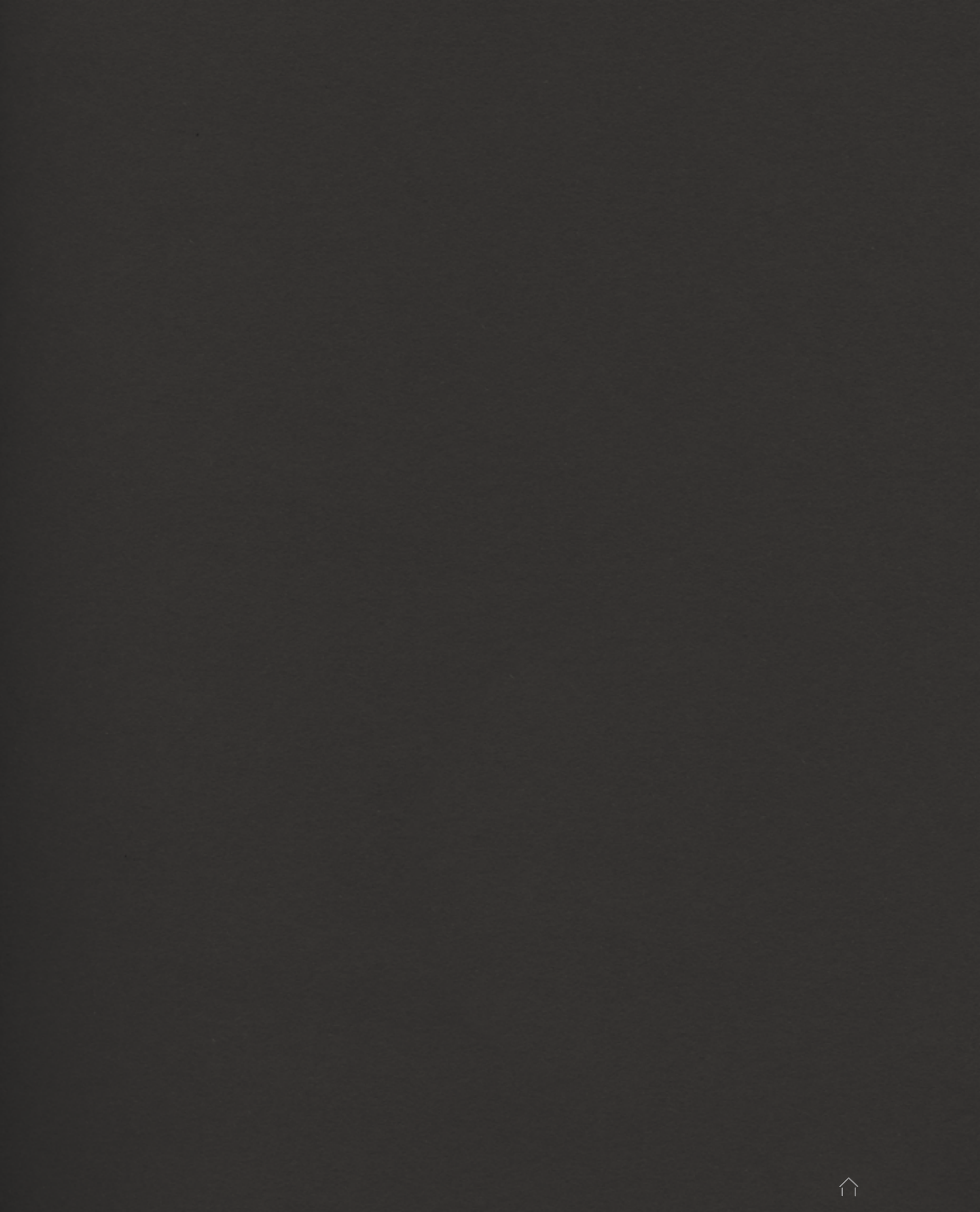
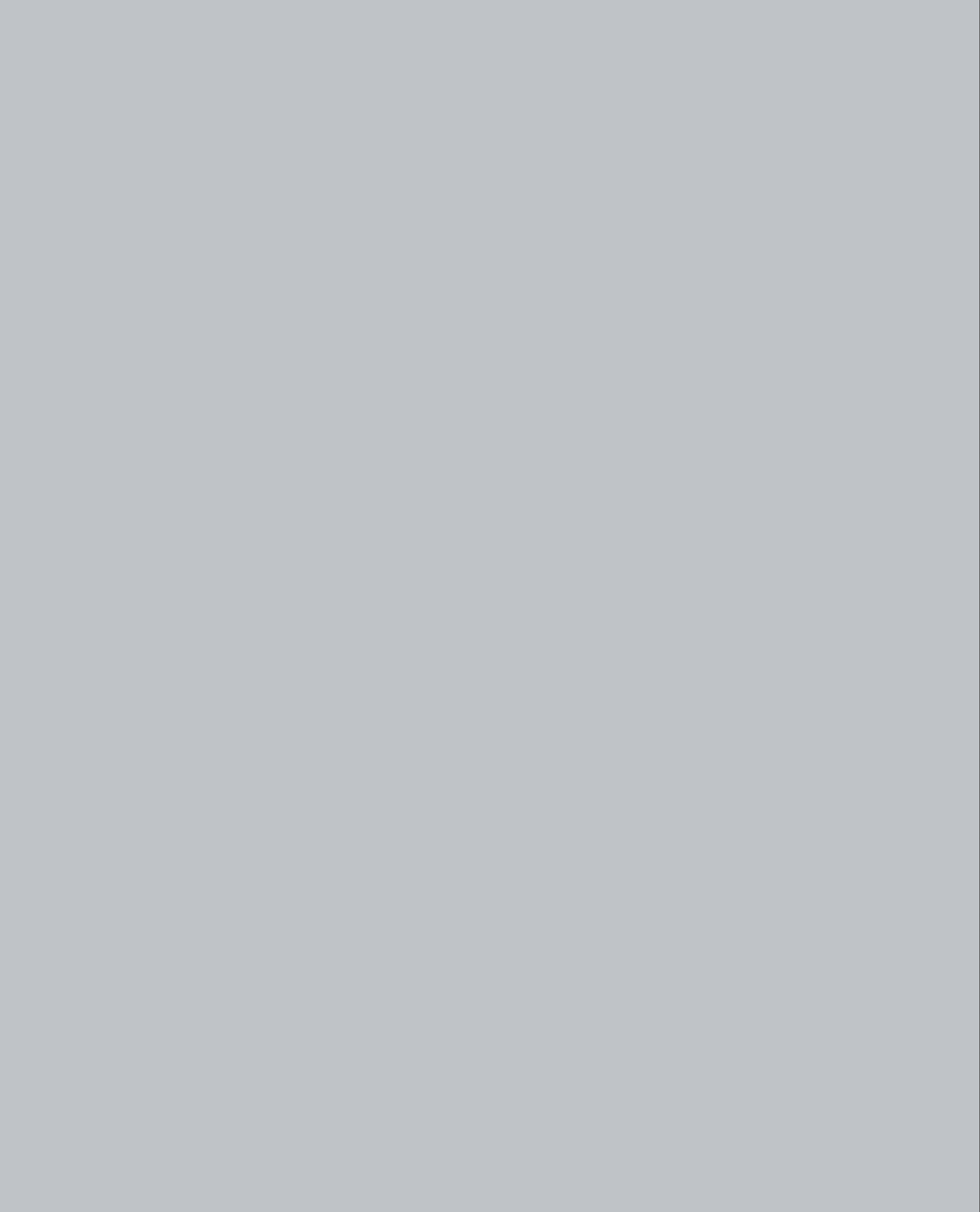

Sleeping

