



OUTDOOR

Molteni & C

Outdoor

Molteni & C | OUTDOOR

The Outdoor Collection

“Feeling embraced by Italian savoir faire and inspired by what surrounds us.”

Vincent Van Duysen

Nature is an important part of our life — a connection that aims to rediscover the lost time of seasons and colors, and the pleasure of outdoor living, accompanied by furniture and objects designed especially for welcoming spaces. The Outdoor Collection seamlessly bridges indoor and outdoor realms, personal and shared spaces. It narrates the essence of living al fresco, intertwining freedom and a deep connection to nature through meticulously crafted furnishings designed for inviting spaces steeped in sustainability. Continuing to make its mark in the outdoor domain, the collection expands its offerings while upholding the exclusivity of Italian excellence, refined to perfection — a hallmark of Vincent Van Duysen’s creative universe. The products are interpreted by the most important contemporary designers, from Yabu Pushelberg to Foster + Partners, from Ron Gilad and Gio Ponti.

“Introducing new pieces with a distinctive identity and decorative touch adds another layer to our existing collection. We remain committed to the art of living cultivated since the inception of our outdoor journey”.

La natura è parte integrante del nostro modo di vivere: una connessione volta a ritrovare il tempo perduto delle stagioni e dei colori, riscoprire il vivere all’aria aperta, accompagnati da arredi e oggetti pensati per spazi accoglienti. Una libertà quanto mai ricercata, una sensibilità — quella del vivere *en plein air* — che ha molto a che fare con il rispetto per la natura e con il concetto di sostenibilità. La nuova proposta Outdoor trae ispirazione dall’esclusività dell’eccellenza italiana, ricercata e raffinata. Caratteristiche proprie anche dell’universo creativo del direttore artistico Vincent Van Duysen, che ha coordinato due ampie collezioni che si arricchiscono ogni anno di nuovi pezzi firmati dai più prestigiosi designer contemporanei, da Foster + Partners a Ron Gilad, da Yabu Pushelberg a Gio Ponti.

“Il successo della collezione inaugurale di Molteni&C Outdoor ci conduce all’introduzione di nuovi pezzi denotati da un’identità distintiva e da un tocco decorativo, per aggiungere un ulteriore layer alla nostra collezione esistente. Tenendo sempre a mente l’arte del vivere coltivata sin dai primi passi del nostro itinerario all’aria aperta.”



Landmark, the collection characterized by solid teak, is harmoniously designed to allow outdoor spaces to be experienced with comfort and elegance. It is a true milestone, a reverence that enhances Molteni&C's mastery in magnifying natural elements into furniture with timeless appeal. The **Fairmount** table in solid teak is Vincent Van Duysen's testament to magnificently transferring the art of living from indoor to outdoor spaces and can be complemented with two seating solutions, **Cobea** and **Boboli**. The Sway modular sofa system by Yabu Pushelberg, with its unmistakably soft and fluid lines, evokes an immersive and engaging experience inspired by the layering concept suggested by nature.

The **Timeout Collection**, instead, features metal as the predominant material. A reference to modernist architecture, where the apparently cold character is mitigated by its fine lines.

A contemporary interpretation of metal, softened by the intertwined ropes of the backrests or the natural materials of the various elements as in the **Petalo** armchair by Vincent Van Duysen, with its masterful weaving of ecru polypropylene ropes.

Noteworthy is the introduction of ceramics in the **Picea** coffee table — a sculptural monobloc offered in anthracite, merlot red, and ecru.

Molteni&C's two outdoor collections are independent but dialogue with each other, with materials playing a starring role, where solid natural teak engages in a dialogue with aluminum profiles.

The dialogue continues with mutual and sophisticated references in the details and in the common color palette, which reflects typically Mediterranean colors, from the warm earthy tones to the hues of olive groves, including merlot red and golden-hours hues that complement the handcrafted polypropylene ropes. The same shades are featured in the rug selection, offering creations by Marta Ferri, Nicola Gallizia and Vincent Van Duysen that add an extra touch of elegance to the outdoor experience.

To enrich the outdoor proposal, a series of timeless elements with a common charm, such as the **Arc** table of Foster + Partners, the **Panna Cotta** coffee table by Ron Gilad and two important projects by Gio Ponti, part of Molteni&C's **Heritage Collection**: the iconic **D.154.2** which finds a new identity and use in its outdoor version, and the **D.150.5** solid wood chaise longue, designed for the cruise ship *Andrea Doria* in 1952.

Landmark, collezione caratterizzata dal massello in teak, è armonicamente studiata per permettere di vivere con comfort ed eleganza gli spazi esterni, esprimendosi attraverso un carattere materico ed emozionale. Il tavolo **Fairmount** di Vincent Van Duysen continua il percorso di connessione tra interno ed esterno e può essere arricchito con le sedute **Cobea** e **Boboli**. Il divano modulare **Sway** di Yabu Pushelberg è una sinfonia di forme e linee ondulate che trae ispirazione dal concetto di stratificazione suggerito dalla natura.

La **Collezione Timeout** è invece caratterizzata dal metallo come materiale predominante.

Un richiamo alle architetture moderniste, dove il carattere apparentemente freddo viene addolcito dalle sue linee sottili.

Un'interpretazione contemporanea del metallo, ingentilito dagli intrecci delle corde degli schienali o dai materiali naturali dei vari elementi, come nella poltrona **Petalo** di Vincent Van Duysen con i suoi intrecci di corde in polipropilene ecru.

Degna di nota, l'introduzione del tavolino **Picea**, elemento scultoreo dai toni antracite, merlot red ed ecru.

Le due collezioni Outdoor di Molteni&C sono indipendenti ma dialogano tra di loro grazie a reciproci e sofisticati richiami nei dettagli e nella palette cromatica comune, che riporta a colori tipicamente mediterranei con le sfumature calde della terra e le cromie degli uliveti, come le tinte merlot-red e golden-hour che si combinano ai toni delle corde intrecciate di polipropilene.

Le stesse tonalità vengono proposte nei tappeti: creazioni firmate da Marta Ferri, Nicola Gallizia e Vincent Van Duysen, regalano un ulteriore tocco di eleganza all'esperienza outdoor.

Ad impreziosire la proposta Outdoor, una serie di elementi comuni dal fascino senza tempo come il tavolo **Arc** di Foster + Partners o il tavolino **Panna Cotta** di Ron Gilad, appositamente studiato per essere esposto all'esterno. Si aggiungono inoltre due importanti progetti di Gio Ponti, che arricchiscono l'**Heritage Collection**: l'iconica **D.154.2** che, già nel catalogo indoor, trova un'inedita identità nella sua versione outdoor, e la chaise longue **D.150.5** in legno massello, progettata da Gio Ponti per la nave da crociera *Andrea Doria* nel 1952.



LANDMARK COLLECTION

Landmark takes shape from fluid, organic lines, and the distinct materiality of the elements.

A design without corners, characterized by the woven teak wood motif, EVA polyurethane and polypropylene, that circumscribes the back, embracing the material with comfort and design. Everything is softened and cozy: the furnishings are soft to the touch, the structures have no edges, even in the connections between seat and supportive frame.

The wooden elements are rich in details, curves and joints of high cabinet making, thus enhancing their sculptural forms. They reflect the Molteni&C DNA, which stems precisely from the working of wood, here reinterpreted through a design that can express the wisdom and skill of tradition with a contemporary aesthetic language, drawing inspiration from the lessons of the leading architects who have worked with the Company in interpreting wood. Like Luca Meda, to whom homage is paid with the production of *Palinfrasca*, the sofa inspired by a 1994 work by the architect.

Integrating seamlessly into this collection are the Fairmount Table by Vincent Van Duysen, meticulously crafted from exquisite solid teak, and the Sway Modular Sofa System by Yabu Pushelberg, a groundbreaking outdoor ensemble with unparalleled versatility and fluid forms.

Complementing these are the Cobeia Chair and the Boboli Armchair and Sofa, both designed by Vincent Van Duysen, showcasing exceptional craftsmanship and embodying the qualities of rarity and preciousness.

Each piece adds its unique charm, enhancing the Landmark Collection with a harmonious blend of comfort, style, and meticulous design.

Landmark prende forma da linee fluide e organiche e dalla spiccata matericità degli elementi. Un disegno senza angoli, caratterizzato dal motivo intrecciato in legno di teak o poliuretano EVA, che circonda lo schienale, per abbracciare con comfort e design. Tutto è ingentilito e accogliente: gli arredi sono morbidi al tatto, le strutture prive di spigoli, perfino nei raccordi tra seduta e struttura portante.

Gli elementi in legno sono ricchi di dettagli, curvature e incastri di alta ebanisteria, risaltandone così le forme scultoree. Rispecchiano il DNA di Molteni&C che nasce proprio dalla lavorazione del legno in essenza, qui riletto attraverso un design che sa interpretare la sapienza e la maestria della tradizione con un linguaggio estetico attuale, traendo spunto dalla lezione dei protagonisti dell'architettura che hanno interpretato il legno insieme all'Azienda. Come Luca Meda, al quale viene reso omaggio con la produzione di *Palinfrasca*, il divano che trae ispirazione proprio da un'opera del 1994 firmata dall'architetto.

Integrati alla perfezione nella collezione, il tavolo Fairmount di Vincent Van Duysen, ideato e realizzato in pregiato teak massello, e il divano modulare Sway di Yabu Pushelberg che ridefinisce i confini degli spazi outdoor grazie alla versatilità, la componibilità e la fluidità delle forme.

A complemento, la sedia Cobeia e la poltrona e divano Boboli, entrambi di Vincent Van Duysen, pezzi curati che incarnano le qualità di rarità e preziosità.

Ogni pezzo dal fascino unico arricchisce la Collezione Landmark con un armonioso mix di comfort, stile e design meticoloso.

TIMEOUT COLLECTION

The Timeout Collection the theme of metal, presenting it in a modern way on a range of furnishings: two-seater sofa, armchair, chair, sunbed, stool, bench, low table and dining table - to define plein air environments or spaces half indoors and half outdoors.

Van Duysen draws his inspiration from the tradition of fer forgé, reserving for the metal a formal precision and purity that recalls elegant, modernist languages. The coldness of aluminum is warmed by the burnished paint, a color that evokes the natural world, such as the browns of earth, lit up by warmer tones.

The proposal is distinguished by the aluminum band which, continuously bending, creates the support structure, the armrests, and the support feet. The 'woven' theme becomes purely evocative in the metal, linked to the idea of movement rather than mere form, minimal without losing its material sensuality. Instead, the "weaving" becomes explicit in the upholstery of the structure, made of a weave of polyethylene fibre ribbons masterfully executed by hand.

The Timeout Collection seamlessly integrates the gentle curves and enveloping backrest of the Petalo Armchair and Pouf by Vincent Van Duysen, redefining outdoor elegance. Additionally, the Picea Outdoor Coffee Table by Van Duysen, crafted in ceramic with rounded lines, adds durability and subtle grace, setting the tone for sophisticated moments spent in nature.

La Collezione Timeout interpreta il tema del metallo, declinandolo in modo moderno in tutta la ricca proposta di arredi, come: divano a due posti, poltrona con o senza braccioli, sedia con o senza braccioli, lettino, sgabello, panca, tavolino basso e tavolo da pranzo - per definire ambienti plein air o spazi tra in e outdoor.

Van Duysen trae ispirazione dalla tradizione del fer forgé, riservando al metallo un rigore formale e una purezza che rimanda a linguaggi eleganti e modernisti. La freddezza dell'alluminio è riscaldata dalla verniciatura color brunito, cromia che richiama il mondo naturale, come i marroni della terra, accesa da tonalità più calde.

La proposta si distingue per la fascia in alluminio che, piegandosi senza interrompersi, crea la struttura di sostegno, i braccioli e i piedini d'appoggio. Il tema dell'intreccio diventa nella parte metallica puramente evocativo: legato all'idea di movimento anziché alla mera forma, minimale senza perdere la sensualità materica. Il "weaving" diviene invece esplicito nel rivestimento della struttura, realizzato con un intreccio, eseguito magistralmente a mano, di nastri in fibra di polietilene.

La Collezione Timeout integra le forme dolcemente tondeggianti e avvolgenti della poltrona e del pouf Petalo di Vincent Van Duysen, ridefinendo l'eleganza dell'outdoor. Degno di nota, il tavolino Picea di Van Duysen, un oggetto integralmente in ceramica e dalle linee armoniose e finemente arrotondate. Il tavolino risulta di perfetta compagnia nei più svariati momenti trascorsi all'aria aperta.



Sway Sofas and coffee tables Yabu Pushelberg Boboli Armchair Picea Coffee table Vincent Van Duysen



Sway Sofas and coffee tables Yabu Pushelberg Picea Coffee table Vincent Van Duysen



Sway Sofas and coffee tables Yabu Pushelberg







Sway Sofa and coffee tables Yabu Pushelberg Petalo Armchair Picea Coffee table Vincent Van Duysen



Sway Sofa and coffee tables Yabu Pushelberg



Outdoor



D.150.5 Armchairs *Gio Ponti* Regent Coffee table *Vincent Van Duysen*



Sway Sofa Yabu Pushelberg Picea Coffee table Vincent Van Duysen



Boboli Sofa and armchairs Fairmount Lounge table Vincent Van Duysen







Sway Sofa and coffee table Yabu Pushelberg Boboli Armchair Vincent Van Duysen







Fairmount Table Cobeia Chairs Hedera Carpet Vincent Van Duysen



Fairmount Table Cobeia Chairs Vincent Van Duysen

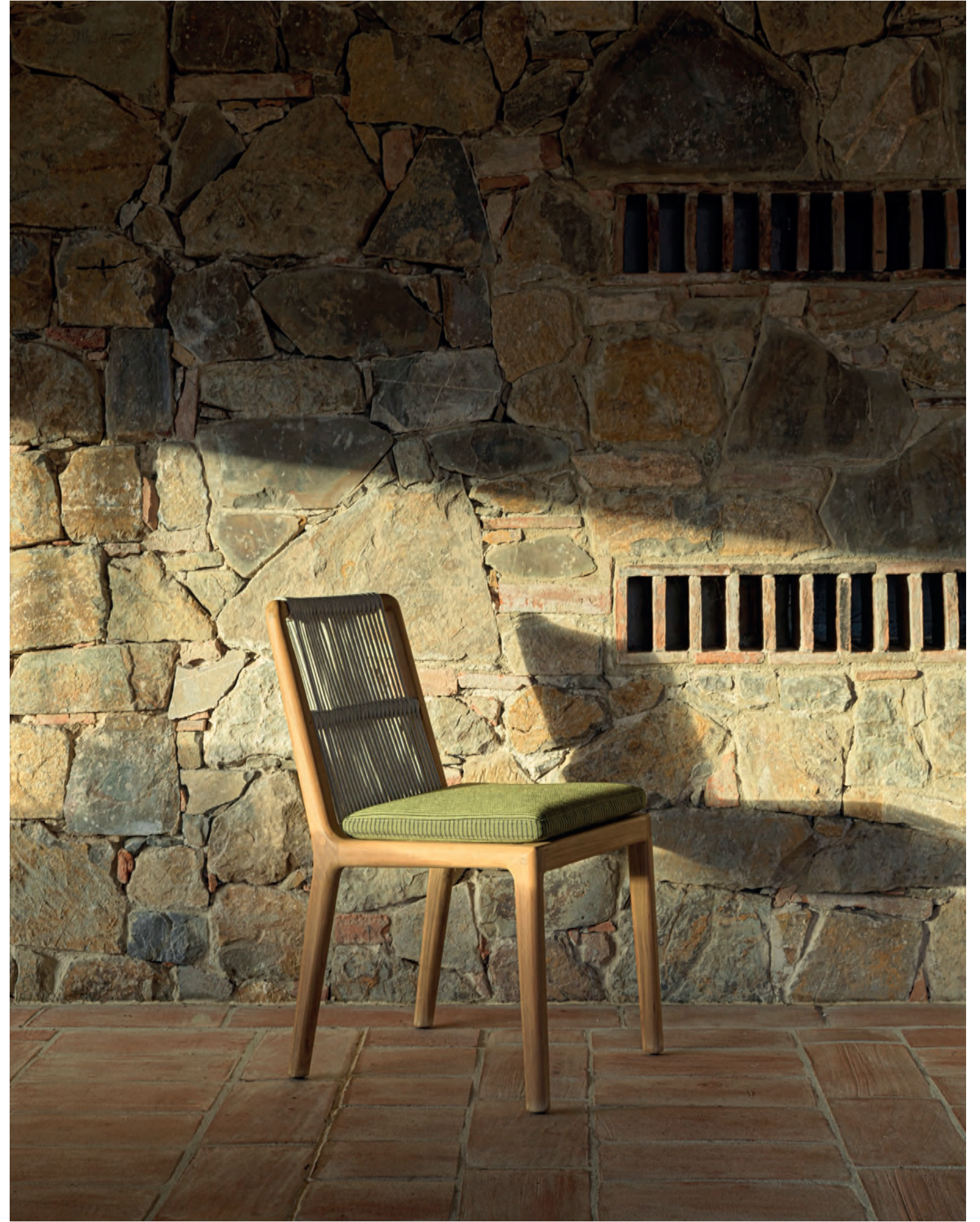



Petalo Armchairs Vincent Van Duysen







A union between architecture and nature

"For me, Karl Blossfeldt's work represents an important link between architecture and nature. It is the same link that I wanted to include in the elements of this outdoor proposal.

His subjects - flowers, plants, botanical elements - are the perfect match to juxtapose with the furnishings of the two new collections. For the interpretation of this union, I decided to rely on the creative flair of the photographer Frederik Vercruysse, who, with his minimalist approach, has captured with great purity the organic and sinuous forms of the elements of the collections, which find a perfect match in the world of botany".

Vincent Van Duysen

Through his works, Karl Blossfeldt was able to transcend the medium of expression, rendering images that translate into a universal artistic language, where lines and shapes become a synthesis of expression and iconography.

Thanks to his meticulous talent, he managed to introduce the sculptural dimension into a typically two-dimensional art form such as photography, using the world of botany as his main subject.

Elegant, refined, contemplative; Blossfeldt's shots, in their immediate elegance, render unseen natural details that still today inspire awe and admiration in the beholder.

Nature, like architecture and every other art form, can educate us in beauty and interiority.

"If I give someone a horsetail, he will have no great difficulty making a photographic enlargement of it - anyone can do that. But to observe it, to notice and discover its forms, is something that only a few are capable of."

Karl Blossfeldt

"Il lavoro di Karl Blossfeldt rappresenta per me un legame importante tra architettura e natura. Lo stesso legame che ho voluto inserire negli elementi di questa proposta outdoor.

I suoi soggetti - fiori, piante, elementi botanici - sono l'abbinamento perfetto da giustapporre agli arredi delle due nuove collezioni. Per l'interpretazione di questo sodalizio, ho voluto affidarmi all'estro creativo del fotografo Frederik Vercruysse, che con il suo approccio minimalista, ha colto con grande purezza le forme organiche e sinuose degli elementi delle collezioni, che trovano un perfetto riscontro nel mondo della botanica".

Vincent Van Duysen

Karl Blossfeldt, tramite le sue opere, è stato in grado di trascendere il mezzo espressivo, restituendo immagini che si traducono in un linguaggio artistico universale, dove le linee e le forme diventano sintesi espressiva e iconografica.

Grazie al suo talento rigoroso, è riuscito ad introdurre la dimensione scultorea in una forma d'arte tipicamente bidimensionale come quella della fotografia, utilizzando il mondo della botanica come soggetto principale.

Eleganti, plastici, contemplativi; gli scatti di Blossfeldt nella loro immediata eleganza, restituiscono dettagli naturali mai visti, che ancora oggi creano stupore e ammirazione in chi li osserva.

La natura, come l'architettura e ogni altra forma d'arte, sono in grado di educarci alla bellezza e all'interiorità.

"Se do a qualcuno un equisetto, non avrà grandi difficoltà a fare una presa fotografica atta a supportare un'argomentazione; ma osservare, notare e scoprire le forme di quell'equiseto è qualcosa di cui solo pochi sono capaci."

Karl Blossfeldt



Karl Blossfeldt, *Adiantum pedatum*, before 1932





Karl Blossfeldt, *Silphium laciniatum*, before 1928



Karl Blossfeldt, *Adiantum pedatum*, before 1926





Karl Blossfeldt, *Chrysanthemum parthenium*, before 1928



Karl Blossfeldt, *Cirsium canum*, before 1932



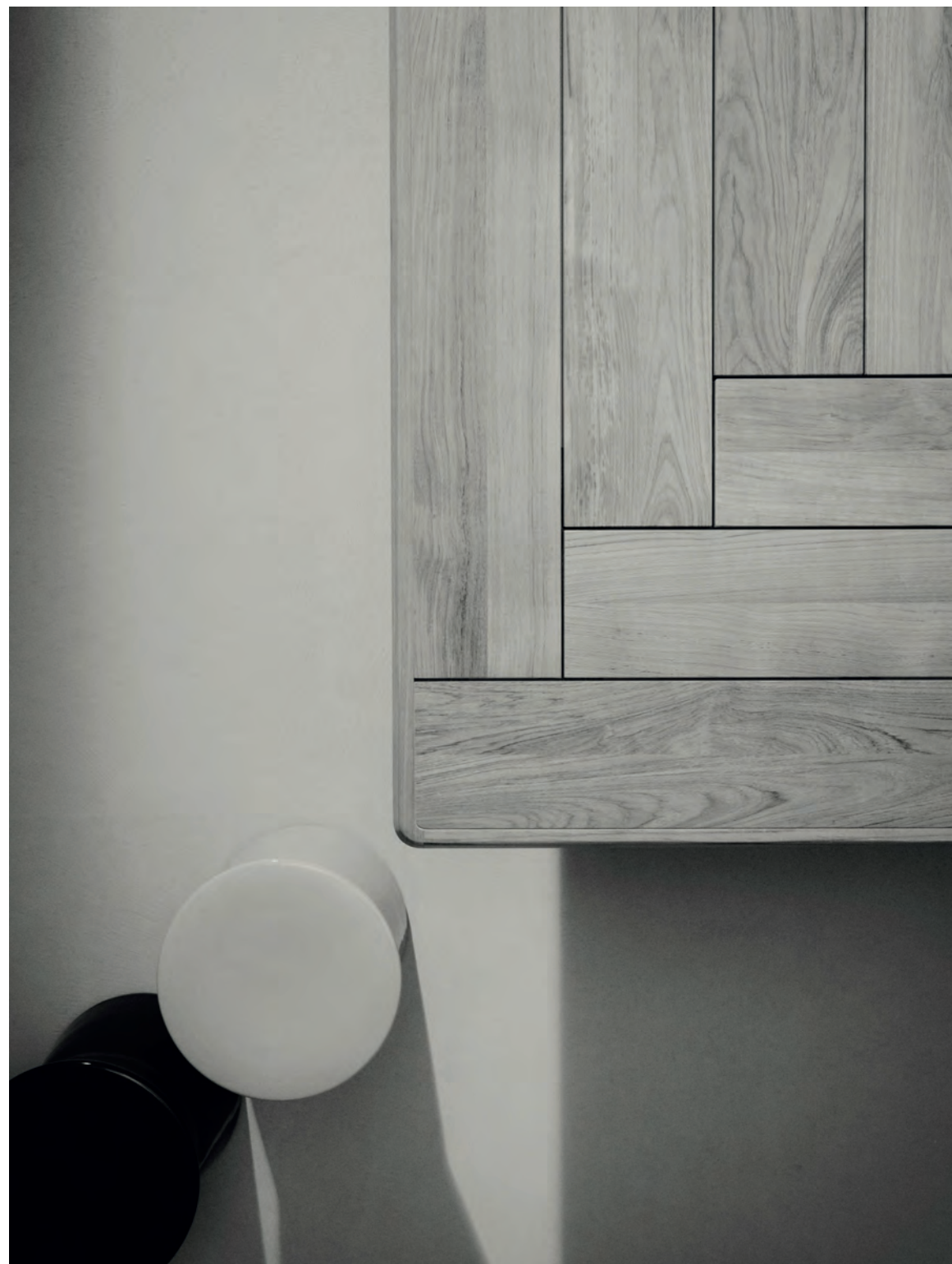

Karl Blossfeldt, *Eryngium bourgatii*, before 1928



Karl Blossfeldt, *Dianthus plumarius*, before 1932











Palinfrasca Sofas Phoenix Armchairs and coffee tables Regent Coffee tables Vincent Van Duysen



Palinfrasca Sofas Regent Coffee table Vincent Van Duysen

Palinfrasca Sofa **Phoenix** Armchairs and coffee table *Vincent Van Duysen*

Panna Cotta Coffee table *Ron Gilad*





Palinfrasca Sofa Phoenix Coffee table Vincent Van Duysen







Palinfrasca Sofas Phoenix Armchairs and coffee tables Regent Coffee tables Vincent Van Duysen



Palinfrasca Seating System Phoenix Coffee tables Regent Coffee tables Vincent Van Duysen







D.154.2 Armchairs *Gio Ponti*
Panna Cotta Coffee table *Ron Gilad*







Phoenix Sofas, armchairs and coffee table Green Point Bench Vincent Van Duysen

Panna Cotta Coffee table Ron Gilad

Musco Carpet Marta Ferri



Phoenix Sofa and armchair Green Point Bench Vincent Van Duysen
Musco Carpet Marta Ferri







Phoenix Sofas, armchairs and coffee table *Vincent Van Duysen*

Panna Cotta Coffee table *Ron Gilad*

Palma Carpet *Nicola Gallizia*

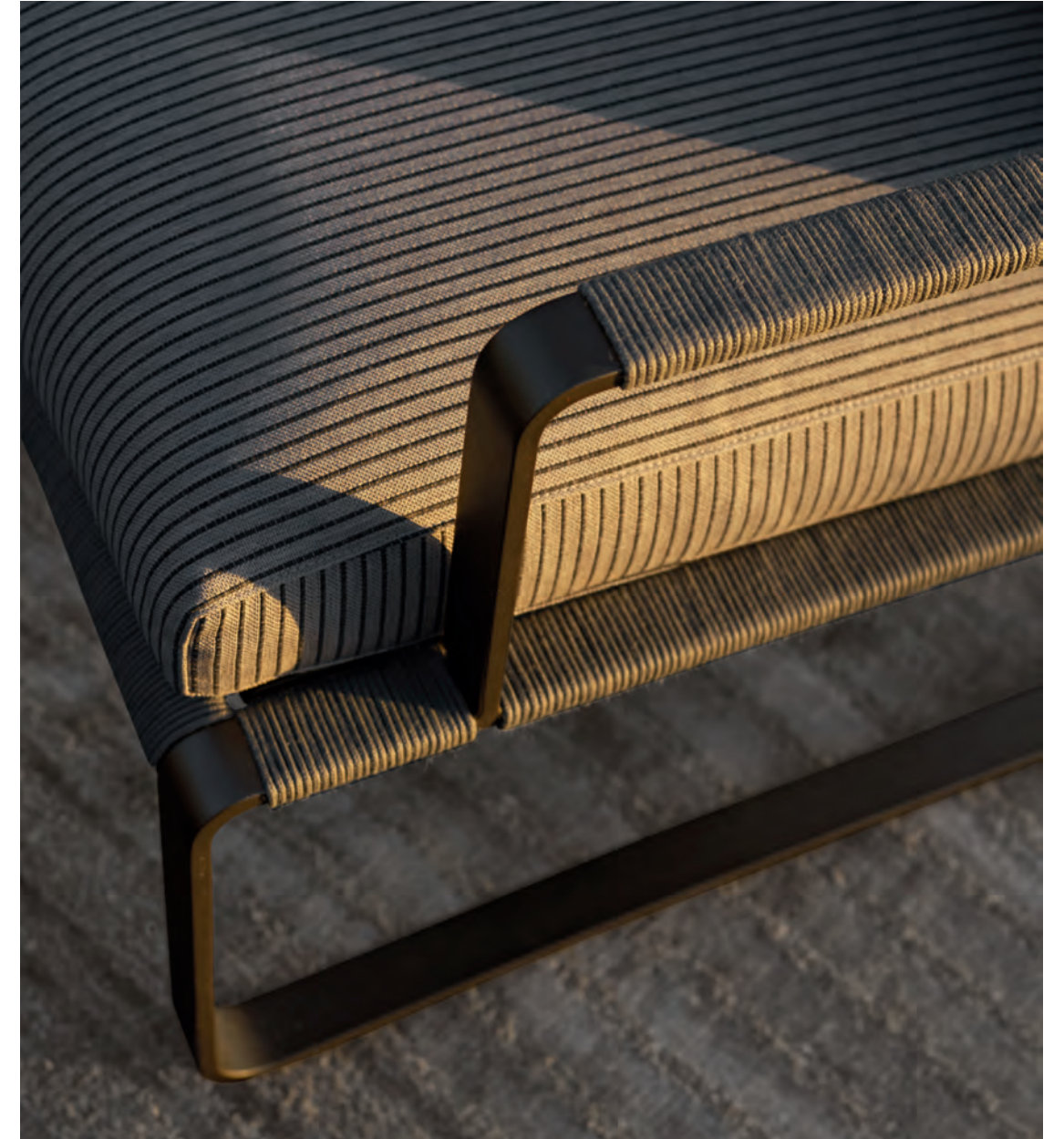

Phoenix Armchair *Vincent Van Duysen*





Arc Table *Foster + Partners*
Green Point Chair *Vincent Van Duysen*
Palma Carpet *Nicola Gallizia*



Hyde Pouf *Vincent Van Duysen*
Panna Cotta Coffee table *Ron Gilad*
Palma Carpet *Nicola Gallizia*



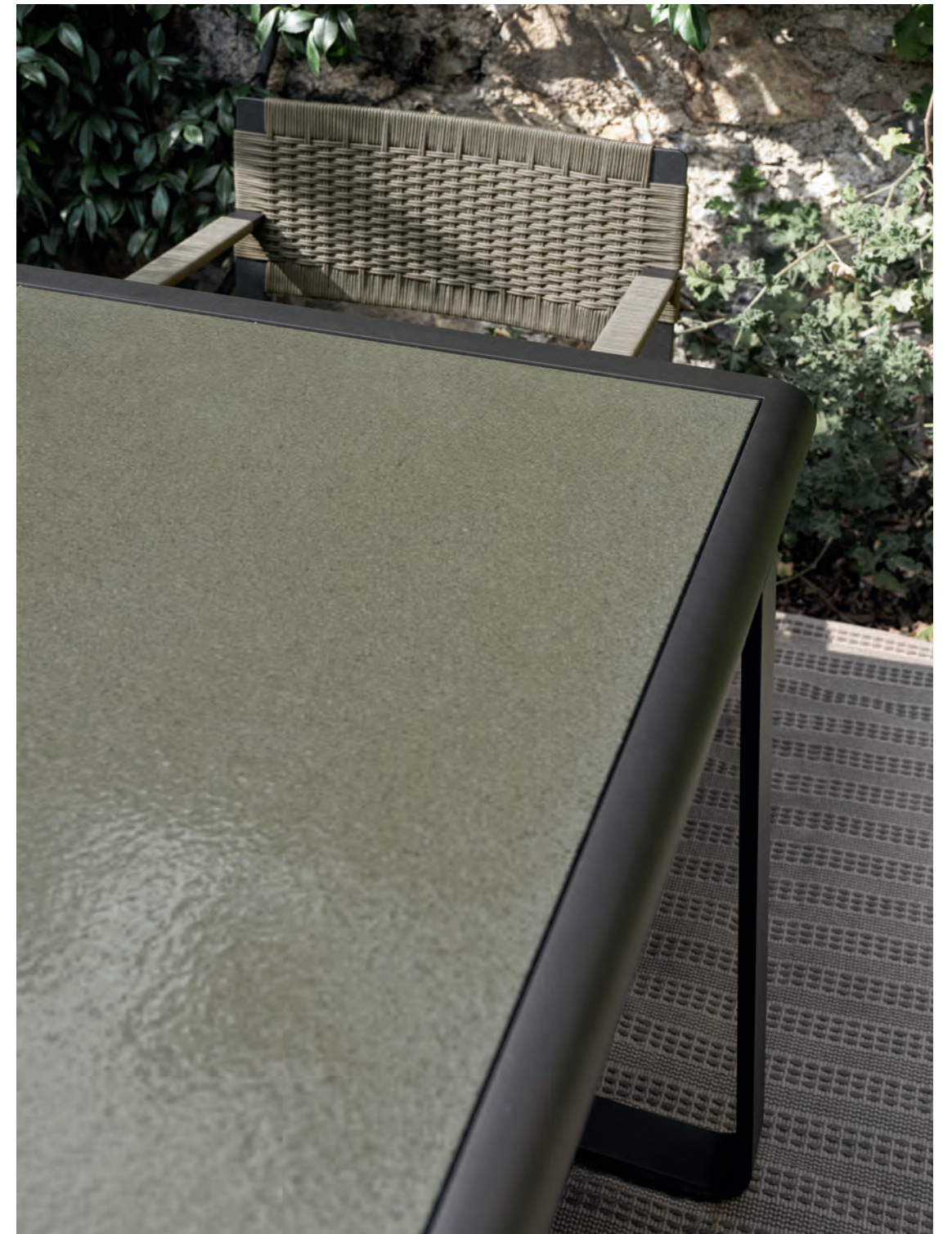







Phoenix Armchairs and coffee table Boulogne Basket Vincent Van Duysen



Guell Sunbeds Regent Coffee table Boulogne Basket Vincent Van Driyen



Gio Ponti / Heritage Collection



D150.5
armchair
Gio Ponti



D154.2
armchair
Gio Ponti

Fairmount
rectangular table
Vincent Van Duysen



Fairmount
round table
Vincent Van Duysen



Landmark Collection



Sway
seating system
Yabu Pushelberg



Sway
coffee tables
Yabu Pushelberg

Fairmount
lounge table
Vincent Van Duysen



Cobea
chair
Vincent Van Duysen



Sway
pouf
Yabu Pushelberg

Palinfrasca
seating system
Vincent Van Duysen



Palinfrasca
armchair
Vincent Van Duysen



Boboli
sofa
Vincent Van Duysen



Boboli
armchair
Vincent Van Duysen

Palinfrasca
pouf
Vincent Van Duysen



Timeout Collection



Petalo
armchairs
Vincent Van Duysen



Petalo
pouf
Vincent Van Duysen

Green Point
chair
Vincent Van Duysen



Green Point
stool
Vincent Van Duysen



Phoenix
sofa
Vincent Van Duysen



Phoenix
armchair
Vincent Van Duysen

Guell
sunbed
Vincent Van Duysen



Regent
coffee tables
Vincent Van Duysen



Phoenix
coffee tables
Vincent Van Duysen



Phoenix
pouf
Vincent Van Duysen

Hyde
pouf
Vincent Van Duysen



Picea
coffee table
Vincent Van Duysen



Golden Gate
table
Vincent Van Duysen



Green Point
bench
Vincent Van Duysen

Boulogne
baskets
Vincent Van Duysen



Ueno
screen
Vincent Van Duysen

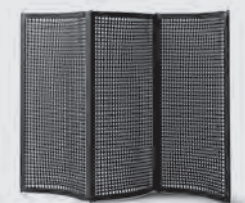

Iconic Pieces



Arc
table
Foster + Partners



Panna Cotta
coffee tables
Ron Gilad

Kitchen Collection



Helios
Vincent Van Duysen

Carpet Collection



Hedera
Vincent Van Duysen



Palma
Nicola Gallizia

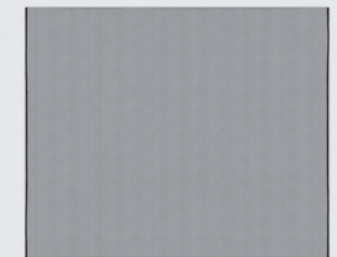

Musco
Marta Ferri

Heritage Collection

D.150.5 GIO PONTI

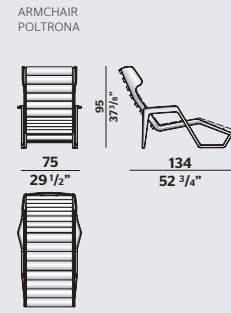

D.154.2 OUTDOOR GIO PONTI

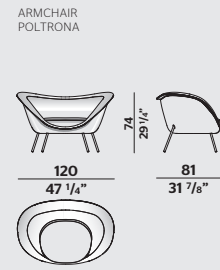

Landmark Collection

SWAY YABU PUSHELBERG

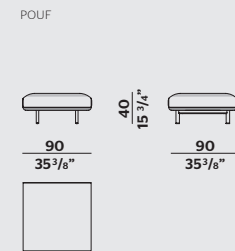
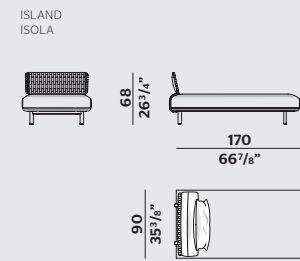
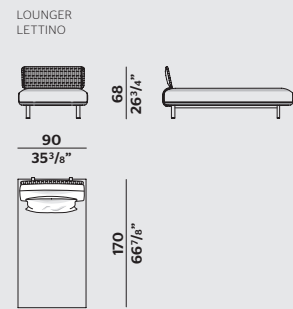
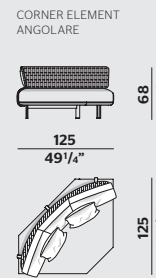
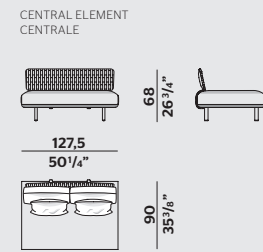
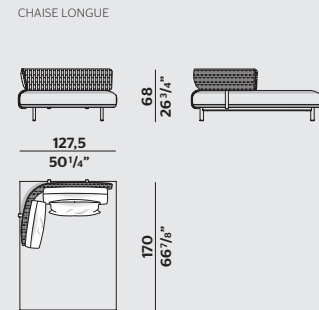
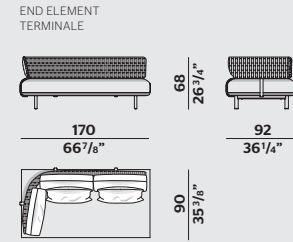
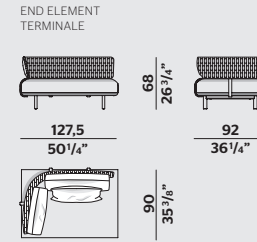
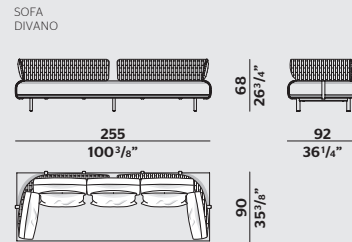
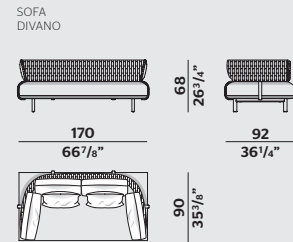

COFFEE TABLES TEAK TAVOLINI TEAK

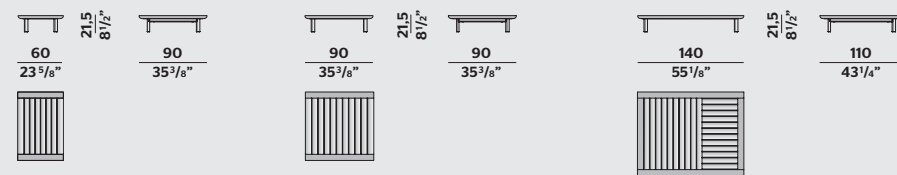

Landmark Collection

COFFEE TABLES COMPLETE WITH STONEWARE TOP TAVOLINI COMPLETI DI TOP IN GRES

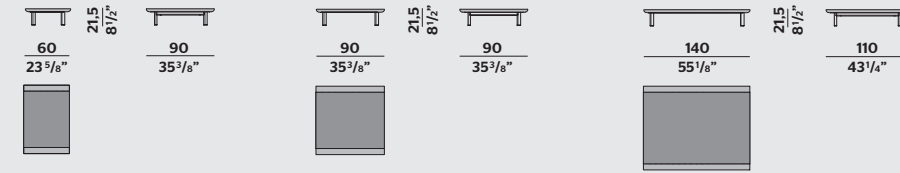

COFFEE TABLES COMPLETE WITH TATAMI TOP TAVOLINI COMPLETI DI TOP IN TATAMI

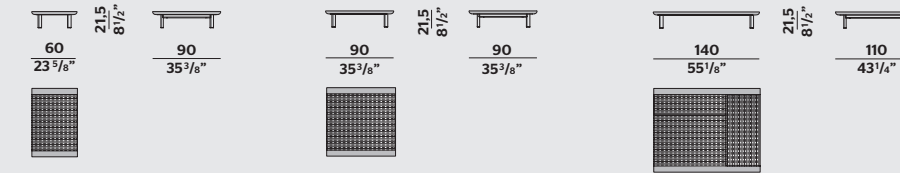

BOBOLI VINCENT VAN DUYSSEN

ARMCHAIR POLTRONA

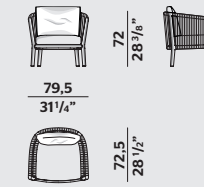

SOFA DIVANO

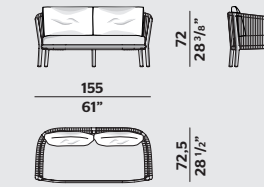

FAIRMOUNT VINCENT VAN DUYSSEN

TABLE TAVOLO

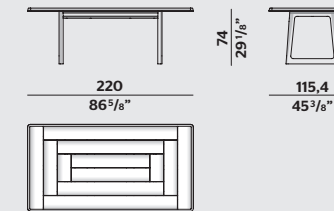
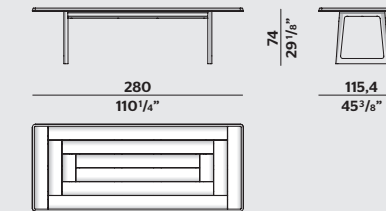
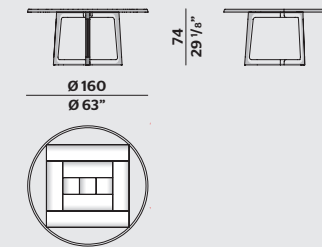

TABLE TAVOLO



ROUND TABLE TAVOLO TONDO



LOUNGE TABLE TAVOLO LOUNGE

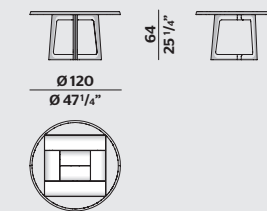

COBEA VINCENT VAN DUYSSEN

CHAIR SEDIA



CHAIR WITH ARMRESTS SEDIA CON BRACCIOLE

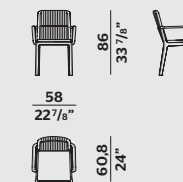

Landmark Collection

PALINFRASCA VINCENT VAN DUYSSEN

ARMCHAIR
POLTRONA

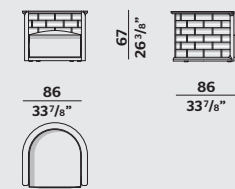

SOFA
DIVANO

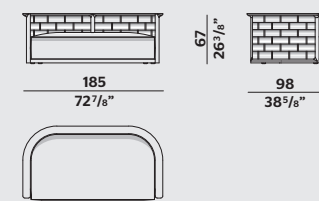

SOFA
DIVANO

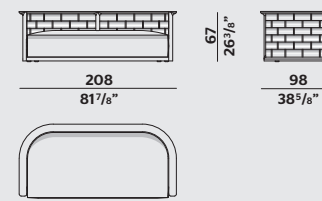

SOFA
DIVANO

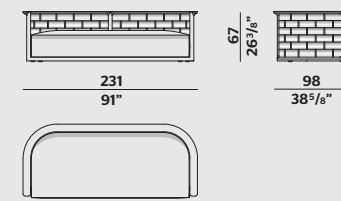

ISLAND
ISOLA

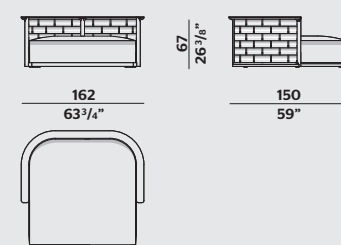

LOVE SEAT

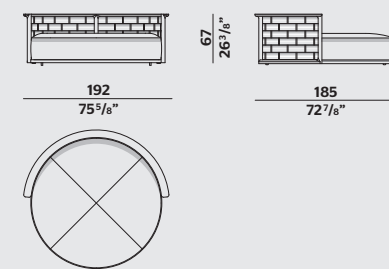

END ELEMENT
TERMINALE

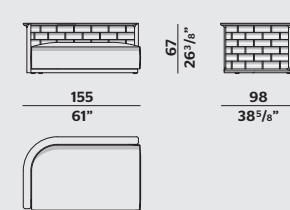

END ELEMENT
TERMINALE

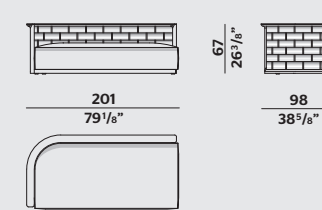

CENTRAL ELEMENT
CENTRALE

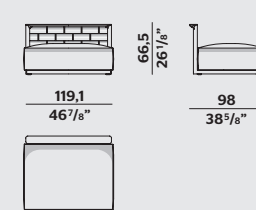

CHAISE LONGUE

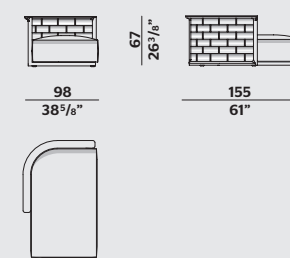

CHAISE LONGUE

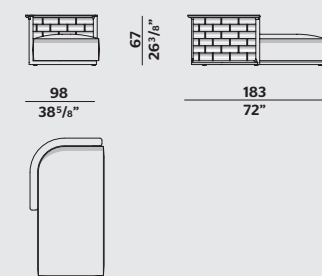

POUF

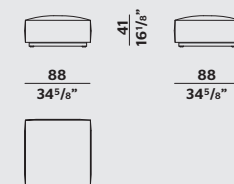

Timeout Collection

PETALO VINCENT VAN DUYSSEN

LOW ARMCHAIR
POLTRONA BASSA

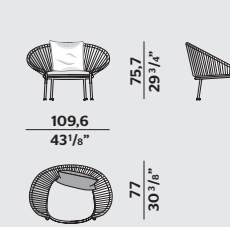

HIGH ARMCHAIR
POLTRONA ALTA

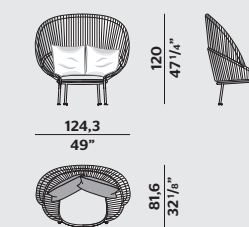

POUF

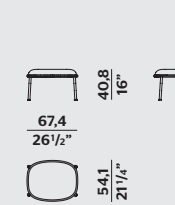

PHOENIX VINCENT VAN DUYSSEN

ARMCHAIR
POLTRONA

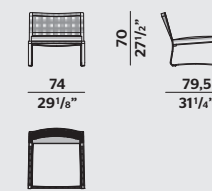

ARMCHAIR WITH ARMRESTS
POLTRONA CON BRACCIOLI

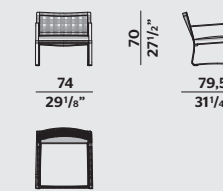

SOFA
DIVANO

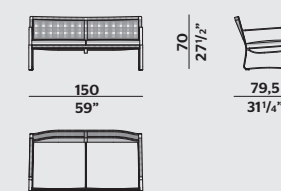

SOFA
DIVANO

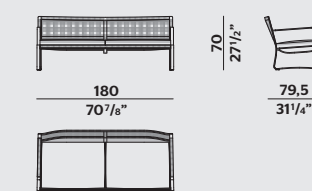

POUF

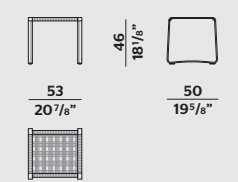

TEAK TOP COFFEE TABLE
TAVOLINO PIANO TEAK

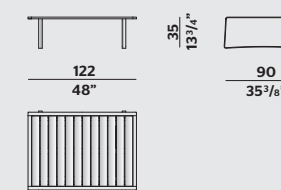

TEAK TOP COFFEE TABLE
TAVOLINO PIANO TEAK

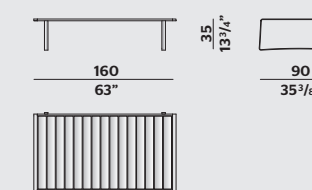

LAVA STONE TOP COFFEE TABLE
TAVOLINO PIANO PIETRA LAVICA

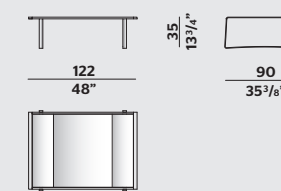

LAVA STONE TOP COFFEE TABLE
TAVOLINO PIANO PIETRA LAVICA

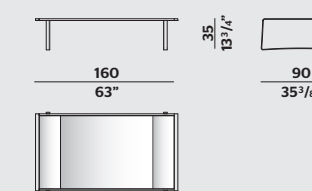

Timeout Collection

GOLDEN GATE VINCENT VAN DUYSSEN

TEAK TOP TABLE
TAVOLO PIANO TEAK

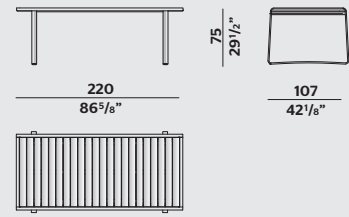

TEAK TOP TABLE
TAVOLO PIANO TEAK

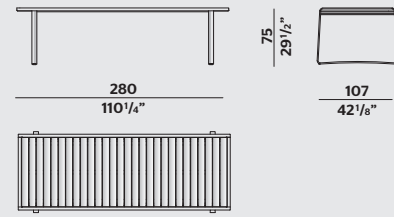

LAVA STONE TOP TABLE
TAVOLO PIANO PIETRA LAVICA

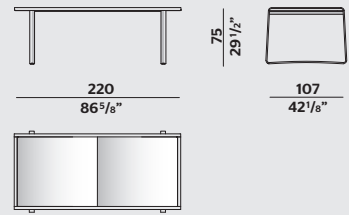

LAVA STONE TOP TABLE
TAVOLO PIANO PIETRA LAVICA

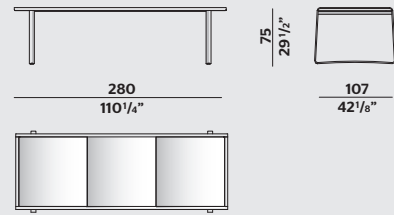

GREEN POINT VINCENT VAN DUYSSEN

BENCH
PANCA

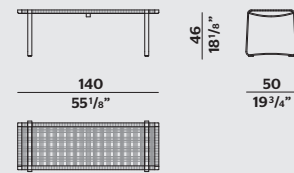

BENCH
PANCA

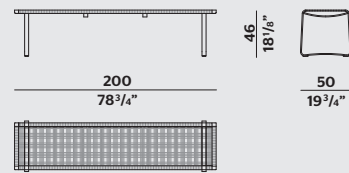

CHAIR
SEDIA

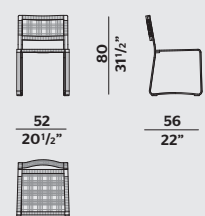

CHAIR WITH ARMRESTS
SEDIA CON BRACCIOLI

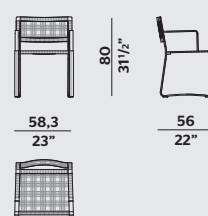

STOOL
SGABELLO

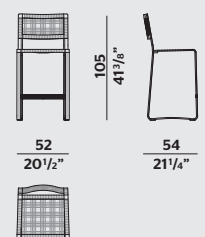

Timeout Collection

GUELL VINCENT VAN DUYSSEN

SUNBED TEAK VERSION
LETTINO VERSIONE TEAK

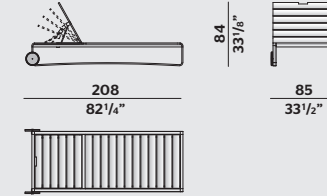

SUNBED WOVEN ROPE VERSION
LETTINO VERSIONE INTRECCIO

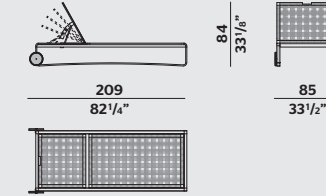

SUNBED BATYLINE VERSION
LETTINO VERSIONE BATYLINE

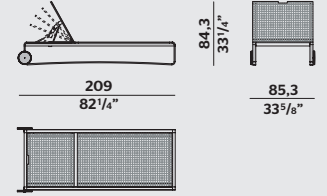

REGENT VINCENT VAN DUYSSEN

RECTANGULAR COFFEE TABLE
TAVOLINO RETTANGOLARE

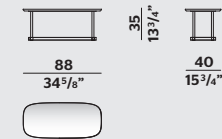

RECTANGULAR COFFEE TABLE
TAVOLINO RETTANGOLARE

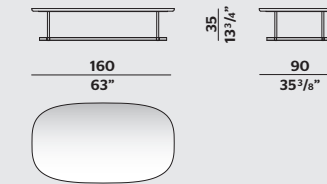

SQUARE COFFEE TABLE
TAVOLINO QUADRATO

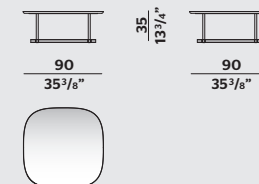

SQUARE COFFEE TABLE
TAVOLINO QUADRATO

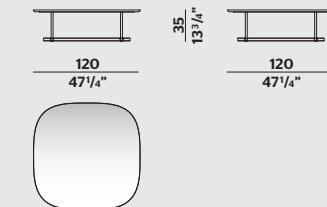

ROUND COFFEE TABLE
TAVOLINO TONDO

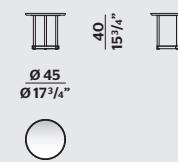

ROUND COFFEE TABLE
TAVOLINO TONDO

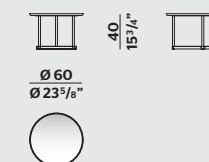

ROUND COFFEE TABLE
TAVOLINO TONDO

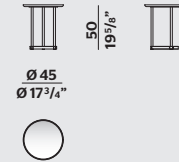

ROUND COFFEE TABLE
TAVOLINO TONDO

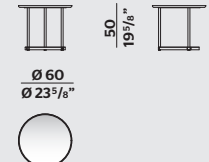

HYDE VINCENT VAN DUYSSEN

POUF

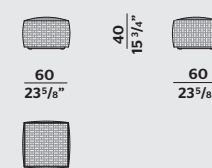

POUF

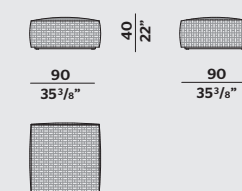

COFFEE TABLE
TAVOLINO

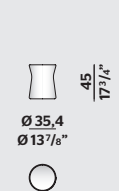

Timeout Collection

BOULOGNE VINCENT VAN DUYSEN

BASKET
CESTA

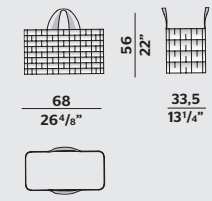

BASKET
CESTA

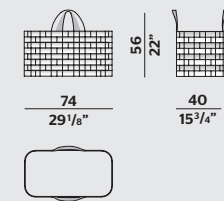

BASKET
CESTA

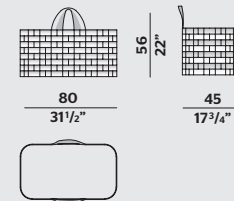

UENO VINCENT VAN DUYSEN

SCREEN
PARAVENTO

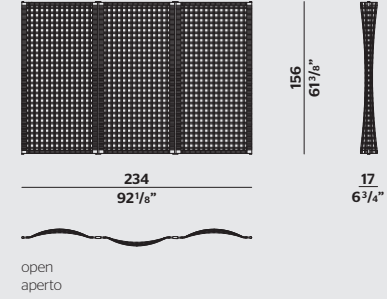

Iconic pieces

ARC FOSTER + PARTNERS

TABLE
TAVOLO

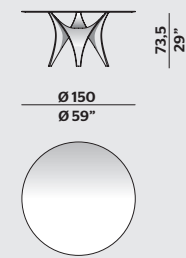

PANNA COTTA RON GILAD

COFFEE TABLE
TAVOLINO

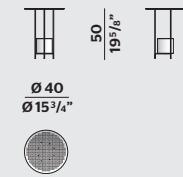

COFFEE TABLE
TAVOLINO

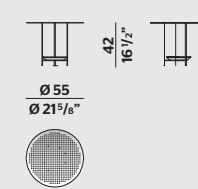

Carpet Collection

HEDERA by Perennials VINCENT VAN DUYSEN

CARPETS
TAPPETI

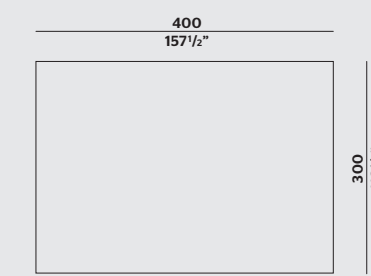
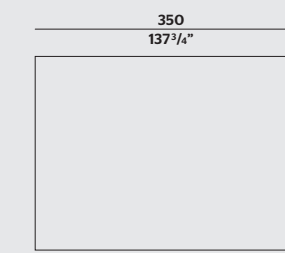
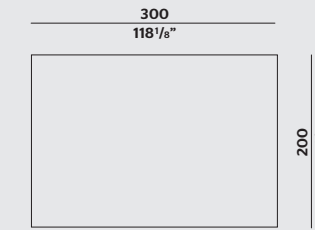

PALMA NICOLA GALLIZIA

CARPETS
TAPPETI

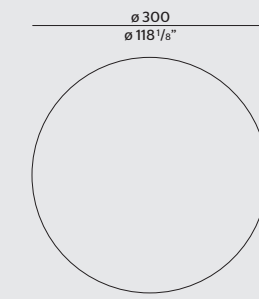
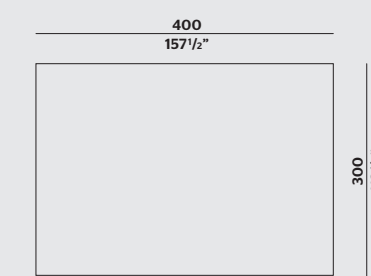
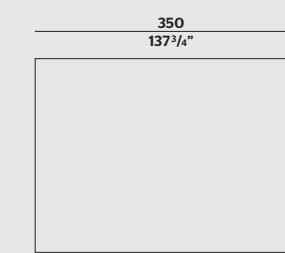
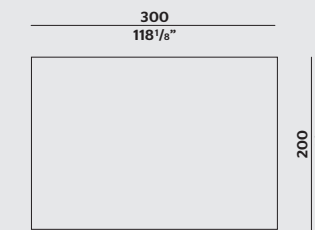

MUSCO MARTA FERRI

CARPETS
TAPPETI

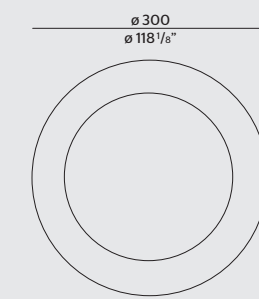
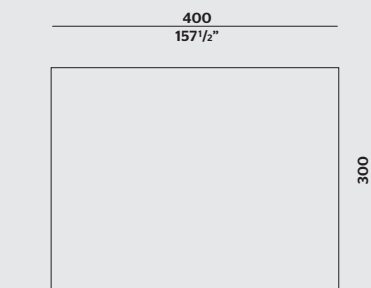
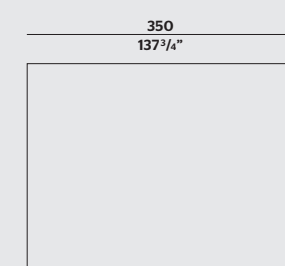
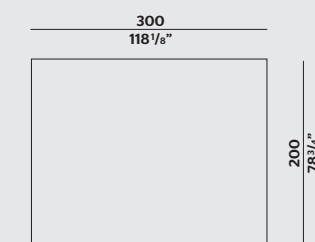

AD—
VINCENT VAN DUYSSEN

PHOTO—
MAX ZAMBELLI
FREDERIK VERCRUYSSÉ

COVER—
KARL BLOSSFELDT,
SILPHIUM IACINIATUM,
BEFORE 1928

THANKS TO—

KARL BLOSSFELDT ARCHIV / STIFTUNG ANN UND JÜRGEN WILDE,
BAYERISCHE STAATSGEMÄLDESAMMLUNGEN, MÜNCHEN

AIKIKO HIRAI
HILLARY KANE
JOJO CORVÁIA
MARC RICOURT
MARCO BELLINI
SABINE PAGLIARULO

REPRESENTED BY KALPA ART LIVING GALLERY

ASTEP
ATELIER VIERKANT
CORRADO CORRADI
DAVIDE GROPPÌ
EDITIONS MILANO
FEDERICA BUBANI
FLOS
IMPERFETTO LAB
LUCEPLAN
LUMINA
MARTINA GERONI
NEMO
ONCE MILANO
PLATEK

CASA NOVINA
VILLA TALAMO



moltenigroup.com
moltenimuseum.com
#MolteniGroup
#MolteniMuseum



@MolteniandC



Molteni&C



@MolteniandC



@MolteniandC



@MolteniandC



MolteniandC



Molteni&C



MolteniC



MolteniandC

OUTDOOR