

Molteni & C

ADRIEN — VINCENT VAN DUYSSEN 2018

1—
6



Adrien expresses a desire to present a new series of storage units, conceptually avant-garde both in technological and in aesthetic terms. Adrien is a fortunate combination of purity of form and exclusive materials and technologies, blended harmoniously and with a focus on key visual and tactile aspects. This new system of storage units develops the concept of rigorous containers defined by absolute transparency. In Adrien the structural aluminium thickness is reduced to a minimum, allowing the Stopsol glass and the built-in LED lighting system of the shelves to enhance the appeal of the objects displayed. A four- or five-door configuration with just one height. The back panel can be made of wood or glass to highlight the complete transparency of the object. The door, made only of glass, opens thanks to a new patented 95° hinge.

DATASHEET

REGISTERED
DESIGN

IX.2023

NOTES

- ▶ Cupboard available in two sizes with sides and doors in glass.
- ▶ The back can be made in the same finish as the sides or in wood.
- ▶ The internal parts are always in wood, and the top can be either in marble th 2 cm or wood th 3 cm.
- ▶ The upper top panel is mandatory.
- ▶ The cupboard can be equipped with a lighting system.
- ▶ The LED bars can be inserted on the lid or on the shelves in wood or glass.
- ▶ The cupboard can be used in the centre of the room only in the version with the glass back.

Molteni & C

2—
6

finishes		woods	pewter colour	transparent glass	transparent stopsol glass	marble	saffiano melamine
components							
side panel	profile						
	glass						
glass frame	profile						
	glass						
frame central partition	profile						
base and lid							
back panel							
glass back panel	profile						
	glass						
finishing top							
door	profile						
	glass						
shelf							
glass shelf	profile						
	glass						
drawers front							
drawer internal							

colours

Woods

EU eucalyptus
RF graphite oak

Marbles

emperador dark
orient grey
Sahara noir
calacatta

DATASHEET

REGISTERED
DESIGN

IX.2023

TECHNICAL INFORMATION

LID, BASE, TOP, FRONTS AND DRAWER STRUCTURE, BACK PANEL AND WOOD TOP

Wood particle board paneling covered with sliced veneer in Eucalyptus (*Eucalyptus globulus*) or Oak (*Quercus*).

GLASS DOOR, SIDES, SHELF AND BACK PANEL

Frame in extruded aluminum with crystal, thickness. 4 mm available in different finishes. The doors open via a recessed hinge in the sides.

FLOOR PROFILE

Extruded anodized aluminum.

SIDES AND DRAWER BOTTOMS

Wood particle board paneling covered with melamine finish.

LIGHTING AND ELECTRICAL COMPONENTS

All components are compliant with regulations and certified as shown on the individual parts.

MARBLE TOP

Marble with finishes from the range.

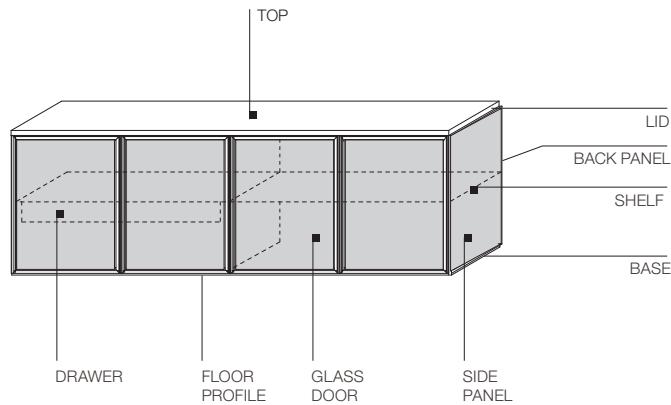

DATASHEET

REGISTERED
DESIGN

IX.2023

DIMENSIONS

cupboard

without internal shelves

H 88 - 34 5/8" wood top
H 87 - 34 1/4" marble top
D 52,7/53,7 - 20 3/4" / 21 1/8"
with glass back panel

transparent glasses

wood top MA08/19E	emperador dark/ orient grey top MA08/19M	Sahara noir/ calacatta top MA08/19S
-----------------------------	---	--

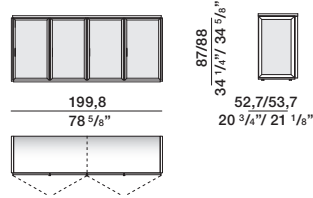

transparent stopsol glasses

wood top MA08/19E	emperador dark/ orient grey top MA08/19M	Sahara noir/ calacatta top MA08/19S
-----------------------------	---	--

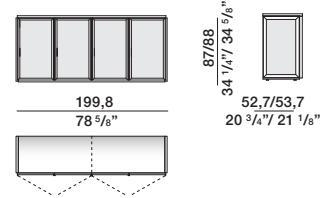

Molteni & C

4 —
6

cupboard

without internal shelves

H 88 - 34 5/8" wood top
H 87 - 34 1/4" marble top
D 52,7/53,7 - 20 3/4" / 21 1/8"
with glass back panel

transparent glasses

wood top MA08/26E	emperador dark/ orient grey top MA08/26M	Sahara noir/ calacatta top MA08/26S
-----------------------------	---	--

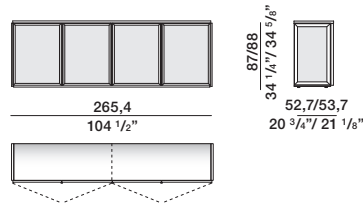

transparent stopsol glasses

wood top MA08/26E	emperador dark/ orient grey top MA08/26M	Sahara noir/ calacatta top MA08/26S
-----------------------------	---	--

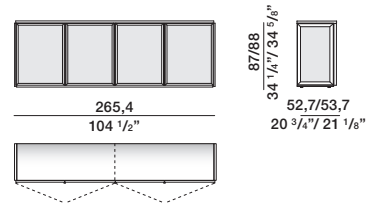

DATASHEET

REGISTERED
DESIGN

IX.2023

DIMENSIONS

It is possible to insert
no. 1 shelf
for compartment

shelf th 3
W 95,4 D 42,8
W 37 1/2" D 16 7/8"

W 128,2 D 42,8
W 50 1/2" D 16 7/8"

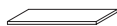

RI/09

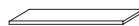

RI/13

Molteni & C

5—
6

To be fastened under
the lid or the
wooden shelf

structure with drawer
H 11,8 - 4 5/8"
module W 95,4 - 37 1/2"

module W 128,2 - 50 1/2"



SCL09/11



SCL13/11

Use of structure with drawer

In the presence of a structure with drawer it is not possible
to apply the LED bar under the lid or shelf

under the lid

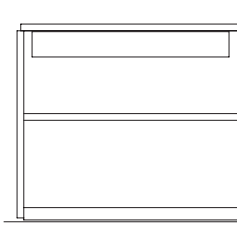

under the wooden shelf

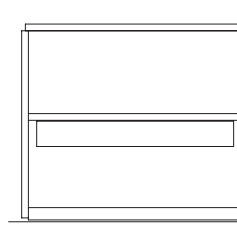

DATASHEET

REGISTERED
DESIGN

IX.2023

DIMENSIONS

Lighting system

Lighting bars with front LEDs

Internal compartments of Adrien can be equipped with front LED lighting bars. The lighting bar can be mounted on the lids or on the shelves in wood or transparent glass, using the electrified wire strip mounted on the left side panel of the compartment. For each compartment size, we have made specific lighting bars with wiring compliant with European safety standards.

Notes

When ordering, the client must indicate how many shelves with lighting bars are desired.

Individual wire strip is always installed on the left side panel of the compartment.

The lighting bars cannot be used in the presence of structures with drawer.

Molteni & C

6—
6

lighting bars	W 95,4 - 37 1/2"	W 128,2 - 50 1/2"
3000 K	6 watt	8 watt

EBI9C

EBI13C

**components
per system**

**power supply unit
block 100W
with watertight box**
(positioned under the
left-side base of each
composition)

electrified wire strip
to insert into the left side
panel of compartments with
lighting bars

**radio control kit
with brightness setting
(1 per power supply unit)
optional**

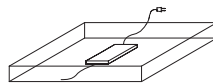

EAB1

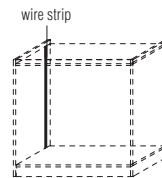

ECA4



EKRR1

DATASHEET

REGISTERED
DESIGN

IX.2023